



Basic

ELECTRONICS

TUTORIALS

*For Beginners
and Beyond*

by **Wayne Storr**

FREE EDITION

BASIC ELECTRONICS TUTORIALS

By Wayne Storr of Electronics-Tutorials.ws

Terms of Use

The information contained within this Basic Electronics Tutorials guide is provided "as-is" and free of charge for general information purposes only on a range of Electronic related topics. All the information and material being published and presented within this particular e-book, including text, graphics and images is the copyright or similar such rights of Wayne Storr representing the website: www.electronics-tutorials.ws, unless otherwise expressly stated.

The purpose of this e-book is as a free study reference guide for the education of its readers who wish to learn Electronics. While every effort and reasonable care has been taken with respect to the accuracy of the information given herein, the author makes no representations or warranties of any kind, expressed or implied, about the completeness, accuracy, omission of errors, reliability, or suitability with respect to the information or related graphics contained within this e-book for any purpose. Any reliance you place on such information is therefore strictly at your own risk.

The information presented within this free e-book is intended for general information and personal use only and is not intended to address your particular problem or requirement. We can not and do not offer any specific technical advice, troubleshooting assistance or solutions to your individual circumstances. However you are encouraged to consult other technical resources or seek professional advice for any additional information or clarification you may need.

Caution

A word of caution. When working with Electrical or Electronics components and circuits, all Electrical Safety procedures must be adhered to and no responsibility is assumed for any injury and/or damage to persons or property as a result of using this guide. It is essential that careful supervision is given to children when working with mains powered electrical and electronic circuits and soldering irons. Thank you and take care.

For more information visit our website at: www.electronics-tutorials.ws

Copyright © 2013 Wayne Storr
www.electronics-tutorials.ws
All rights reserved

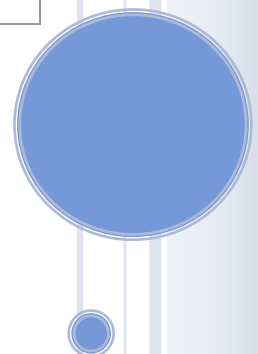

Basic Electronics Tutorials

CONTENTS

1.0 Electrical Theory	3
1.1 The Structure of Atoms	3
1.2 The Unit of Charge	3
1.3 Electric Current	4
1.4 Potential Difference	4
1.5 AC Waveforms	6
1.6 Half-wave Rectified Waveforms	7
1.7 Full-wave Rectified Waveforms	7
1.8 Triangular Waveforms	8
1.9 Sawtoothed Waveforms	8
1.10 Trigger Pulse	8
2.0 Resistances and their Circuits	9
2.1 Resistance	9
2.2 Unit of Resistance	9
2.3 Factors Affecting Its Resistance	10
2.4 Ohms Law	11
2.5 Resistor Power	12
2.6 Resistor Colour Codes	12
2.7 Connecting Resistors Together	14
2.8 Resistors in Series	14
2.9 Voltage Divider Networks	14
2.10 Resistors in Parallel	15
2.11 Two Resistors in Parallel	15
3.0 Capacitors and their Circuits	15
3.1 Capacitance	15
3.2 Unit of Capacitance	16
3.3 Capacitor Types	17
3.4 Connecting Capacitors Together	17
3.5 Capacitors in Parallel	17
3.6 Capacitors in Series	17
4.0 Inductors and their Circuits	18
4.1 Inductance	18
4.2 Connecting Inductors Together	19

Basic Electronics Tutorials

4.3 Inductors in Series.....	20
4.4 Inductors in Parallel.....	20
4.5 Two Inductors in Parallel.....	20
5.0 Impedance and Reactance	21
5.1 Impedance	21
5.2 AC Resistance	21
5.3 Capacitive Reactance	22
5.4 AC Capacitance.....	22
5.5 Inductive Reactance	22
5.6 AC Inductance	23
6.0 RC Filters	23
6.1 Low Pass RC Filter.....	24
6.2 High Pass RC Filter	24
6.3 Band Pass RC Filter	25
6.4 Band Stop RC Filter	25
7.0 Semiconductors	26
7.1 The Semiconductor Diode	27
7.2 Applications Of Diodes	28
7.3 The Zener Diode.....	29
7.4 Zener Voltage Regulator	30
7.5 The Bipolar Junction Transistor	30
7.6 The Field Effect Transistor	32
7.6 The MOSFET	33
8.0 Operational Amplifiers	34
8.1 Inverting Amplifier.....	35
8.2 Non-inverting Amplifier.....	35
8.3 Voltage Follower	35
8.4 Differential Amplifier (Subtractor)	36
8.5 Voltage Summing Amplifier	36
8.6 Integrator Amplifier	36
8.7 Differentiator Amplifier	37

Basic Electronics Tutorials

1.0 ELECTRICAL THEORY

1.1 THE STRUCTURE OF ATOMS

Atoms are not solid but composed of three fundamental particles: **electrons**, **protons**, and **neutrons** arranged in various combinations. The electron is defined as being negatively (-) charged and revolves around the nucleus of the atom in various concentric paths called **orbits**. The proton is defined as being positively (+) charged. Neutrons are defined as being uncharged or neutral. Protons and neutrons are tightly bound together within the atoms nucleus and are not free to orbit.

In an atom the number of negative electrons and positive protons are the same making it electrically neutral. The number of protons present within the atoms nucleus specifies its atomic number. The corresponding numbers of electrons are arranged in different elliptical orbits, called **shells**, around the nucleus. Electrons in different orbits can rotate around the nucleus in all directions, thus producing a three-dimensional atom.

The electrons in the nearest orbit having a great force of attraction while the electrons in the farthest orbit having the least force of attraction. Electrons in the farthest orbit which are loosely held to the nucleus are called **valence electrons** and therefore rotate around the valence shell. Copper for instance, has one valence electron.

An Atoms Structure

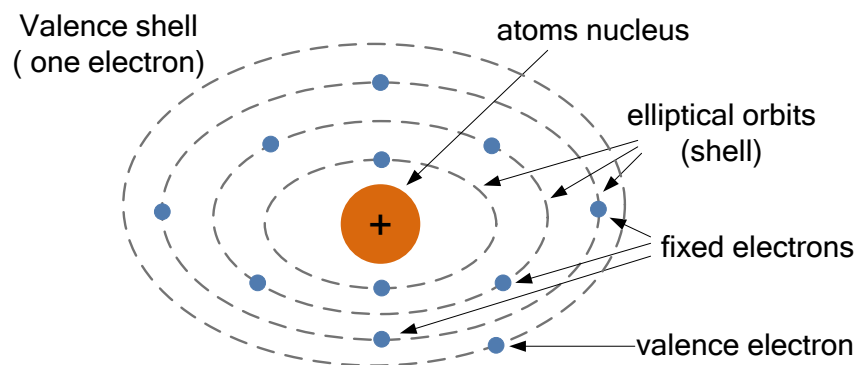

The loosely held electrons in the outer shell often break free due to an input of energy such as heat allowing them to move randomly around through the space in between the various orbits of the other atoms. Such loose electrons are called "free electrons". An atom that loses an electron in this way is left positively charged since it now has an excess of protons. If more electrons attach themselves to the valence shell, then there are more electrons than protons and the atom becomes negatively charged.

1.2 THE UNIT OF CHARGE

The unit of charge is the **Coulomb, C**. The symbol of electric charge is **Q**. The charge of one electron is given as: 1.6×10^{-19} , so one Coulomb of charge is equal to $1 / 1.6 \times 10^{-19}$ or 6.25×10^{18} electrons.

The more free electrons the valence shell has the better the conduction of current by the atom

Thus:

$$Q = 1 \text{ Coulomb} = \text{charge of } 6.25 \times 10^{18} \text{ Electrons}$$

Basic Electronics Tutorials

1.3 ELECTRIC CURRENT

Electric current is the flow of electric charge in the form of free electrons. Current is measured by the number of free electrons passing a particular point within a circuit per second. Therefore the flow of charge per unit second defines the amount of electric current. When the charge moves at the rate of 6.25×10^{18} electrons flowing past a given point per second, the value of the current is one ampere. This is the same as saying one coulomb of charge per second.

The **SI** (*International System of Units*) unit of current is the **ampere** with letter symbol **A**. A constant current has symbol **I**, while a time-varying current has a symbol **i** for intensity. Mathematically we can define the relationship between charge (Q) and electric current (I) as:

Where:

$$I(\text{amperes}) = \frac{Q(\text{coulombs})}{t(\text{seconds})}$$

I = Average Current flowing
Q = Total Charge passing a fixed point
t = Time taken to pass point

Electric current has a direction associated with it. Conventional current flow is in the direction of positive charge movement from positive to negative. Electron flow is in the opposite direction from negative to positive. The arrow in a circuit specifies the direction of positive current flow.

An electric current of one ampere flows in a circuit when a charge of one coulomb passes a given point in one second

In solid metals only negatively charged free electrons move to produce a current flow, the positive protons can not move. But in a liquid or a gas, both the positive protons and negative electrons move to produce a current flow.

Since electric circuits consist almost entirely of solid metal conductors such as copper wire, only negatively charged electrons produce a current flow. Current is also a measure of how intense or concentrated the electron flow is.

1.4 POTENTIAL DIFFERENCE

When two positive charges or two negative charges are brought near to each other they repel while a positive and negative charge are attracted to each other. Then a charged particle has the ability to do work. The ability of a charged particle to do work is called an electric potential. Thus two dissimilar charges have a *difference of potential* and the unit of potential difference (pd) is called the volt.

The **volt** unit of potential difference, named after Alessandro Volta (1745–1827), involves work which is the measure of the amount of work required to move an electric charge, which in turn involves force and distance. The SI unit of work is the *joule* with unit symbol **J**, the SI unit of force is the *newton* with unit symbol **N**, and the SI unit for distance is the meter with unit symbol **m**.

$$W (\text{joules}) = N (\text{newtons}) \times m (\text{meters})$$

Energy is the capacity to do work. *Potential energy*, which is the energy a body has because of its physical position.

Basic Electronics Tutorials

In electronics, potential difference is commonly referred to as voltage, with the symbol **V**. Sometimes the symbol **U** or **E** for emf (electromotive force) is used, but the standard symbol **V** represents any potential difference. This applies either to the voltage generated by a source such as a battery or solar cell, or to the voltage dropped across a passive component such as a resistor.

The voltage difference (also called potential difference) between two points is the work in joules required to move one coulomb of charge from one point to the other. The SI unit of voltage is the volt and is given as:

Where:

$$V(\text{volts}) = \frac{W(\text{joules})}{Q(\text{coulombs})}$$

V = is the Voltage in Volts

W = is the Work done

Q = Total Charge passing a fixed point

A constant voltage is called a DC voltage and a voltage that varies sinusoidally with time is called an AC voltage. A voltage source such as a battery or solar cell provides a constant DC voltage, for example 12 VDC. A voltage source such as an alternator or generator provides an alternating AC voltage, so for example 240 VAC.

If point a is positive with respect to point b, moving a positive charge around a closed circuit from a to b (or a negative charge from b to a) requires work. The difference between the two points is the *voltage polarity*. This voltage polarity is indicated by a positive sign (+) at point a and a negative sign (-) at point b.

The potential difference between two points is one volt if one joule of work is done displacing one coulomb of charge

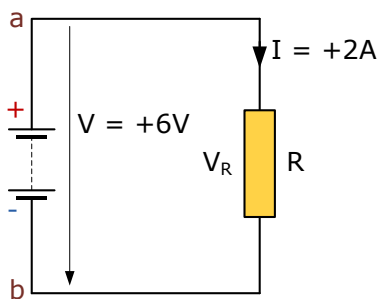

In the circuit the arrow indicates the direction of current flow. If the arrow points in the same direction of the positive charge carriers (conventional current flow) the numeric value of the current receives a positive sign, +2A. If current flow is opposite (electron flow), the numerical value receives a minus sign, -2A. The sign indicates the direction of current flow with the arrow (+) or in reverse (-).

Then **Conventional Current Flow** gives the flow of electrical current from positive to negative and **Electron Current Flow** around a circuit from the negative terminal to the positive. The item which provides a path for the electrons to flow is called a conductor.

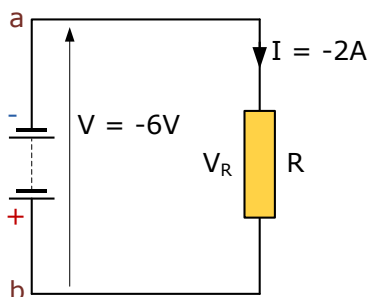

The polarity of the voltage is also indicated by the direction of an arrow. If the arrow points from more positive to more negative potential, the numerical value of the voltage has a positive sign, +6V. If it points from a more negative to a more positive potential, then the numerical value receives a minus sign, -6V.

The battery symbol is often used to denote a DC voltage source, but it may not always be a battery. Usually the positive (+) and negative (-) signs are not shown because, by convention, the long end line denotes the positive terminal (the Anode) and the short end line the negative terminal (the Cathode). Thus, it is not necessary to put + and - signs on the diagram.

For more information visit our website at: www.electronics-tutorials.ws

Basic Electronics Tutorials

1.5 AC WAVEFORMS

Alternating current, (AC) is current that changes direction (usually many times per second) cyclically, passing first in one direction, then in the other through a circuit. Such alternating currents are produced by generators and other such voltage sources whose polarities alternate between a positive direction and a negative direction rather than being fixed in a constant direction as with DC sources. By convention, alternating currents are called *AC currents* and alternating voltages are called *AC voltages*. The most common AC source is the commercial AC power system that supplies energy to your home.

The variation of an AC voltage or an AC current over time is called a *waveform*. Since these waveforms vary with time, AC supplies are designated by lowercase letters $v(t)$ for voltage, and $i(t)$ for current instead of uppercase letters **V** and **I** for DC values. Note that the subscript (t) represents time.

There are many different types and shapes of waveforms but the most fundamental is the sine wave (also called sinusoid). The sine wave or sinusoidal AC waveform is the voltage and current waveform shape at the wall socket outlets in your home.

The waveform starts at zero, increases to a positive maximum (called the peak), and then decreases to zero, changes polarity, increases to a negative maximum, then returns again back to zero. One complete variation between the same points on the waveform is referred to as a **cycle**. Since the waveform repeats itself at regular intervals over time, it is called a **periodic waveform**.

Sinusoidal waveforms are produced by rotating a coil of wire at a constant angular velocity within a fixed magnetic field

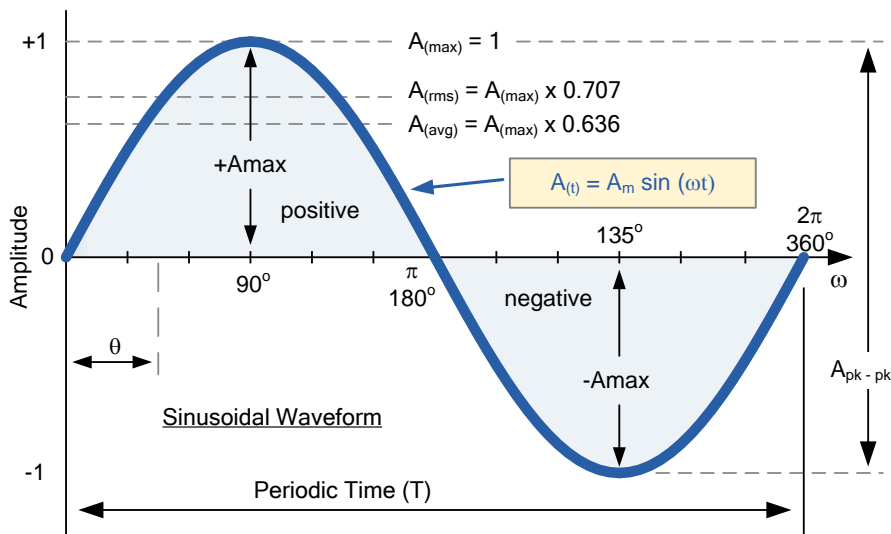

$$f = \frac{1}{T} \text{ (Hz)}$$

$$\omega = 2\pi f \text{ (rads/s)}$$

$$A_{(RMS)} = \frac{A_{\max}}{\sqrt{2}} = 0.7071V_{\max}$$

$$A_{(AVG)} = \frac{2A_{\max}}{\pi} = 0.637V_{\max}$$

$$\text{Form Factor} = \frac{\pi}{2\sqrt{2}} = 1.11$$

$$\text{Crest Factor} = \sqrt{2} = 1.414$$

The calculation of Average, R.M.S, Form Factor and Crest Factor can be use with any type of periodic waveform including Triangular, Square, Sawtoothed or any other irregular or complex voltage or current waveform shape.

For a pure sinusoidal waveform the effective or R.M.S. value will always be equal to $1/\sqrt{2}$ x A_{\max} which is equal to 0.707 x A_{\max} and this relationship also holds true for RMS values of current. The RMS value for a sinusoidal waveform is always greater than its Average value.

Basic Electronics Tutorials

Each repetition of a set of positive and negative instantaneous values of the alternating waveform is called a **cycle**. The sine wave function is periodic in time. This means that the instantaneous value at time t will be exactly the same at a later time. The time taken by the alternating waveform to complete one full cycle is known as its **time period** (also called wavelength in radio), denoted by T seconds.

An Alternating Current (AC) waveform is defined as one which changes periodically both in magnitude and direction

The number of cycles per second of a waveform is defined as its **frequency**. Then we can say that frequency is the reciprocal of the time period as $f = 1/T$, and has the unit of inverse seconds, s^{-1}

In the SI system, the unit of frequency is the **hertz** (Hz) and by definition:

$$1 \text{ Hertz (Hz)} = 1 \text{ cycle per second}$$

Angular frequency (ω) is the waveforms frequency expressed in electrical radians per second. As one cycle of an alternating waveform corresponds to 2π radians, the angular frequency can therefore be expressed as: 2π cycles/sec. Angular frequency has the units of radians/second. The relationship between frequency, f and angular frequency, ω is:

$$\omega = 2\pi f \text{ rad/sec. or } \omega = \frac{2\pi}{T} \text{ radians/sec.}$$

The advantage of using alternating voltages and currents for electronic power supplies is that they can be raised and lowered with the help of a device called a transformer. In DC circuits, raising and lowering voltages is not so easy because transformers cannot be used with direct current.

1.6 HALF-WAVE RECTIFIED WAVEFORMS

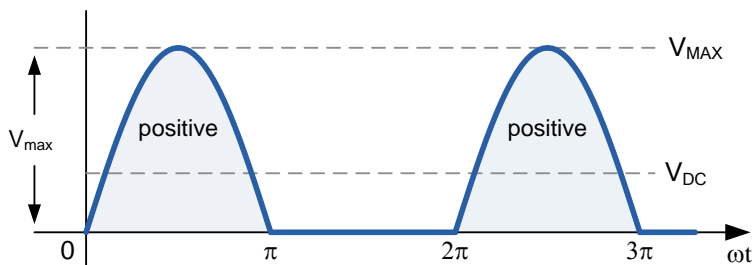

$$V_{DC} = \frac{V_{max}}{\pi} = 0.318 V_{max}$$

$$\text{Ripple Factor} = 1.21$$

$$\text{Form Factor} = \frac{\pi}{\sqrt{2}} = 2.22$$

1.7 FULL-WAVE RECTIFIED WAVEFORMS

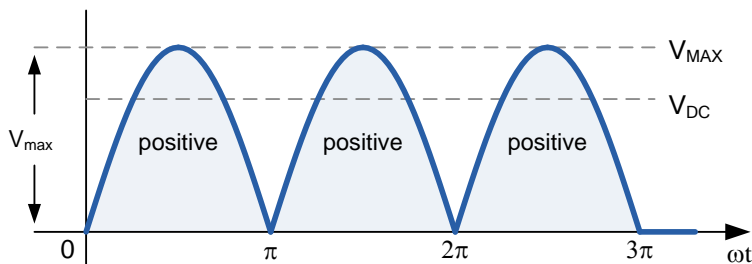

$$V_{DC} = \frac{2V_{max}}{\pi} = 0.636 V_{max}$$

$$\text{Ripple Factor} = 0.482$$

$$\text{Form Factor} = \frac{\pi}{2\sqrt{2}} = 1.11$$

Basic Electronics Tutorials

1.8 TRIANGULAR WAVEFORMS

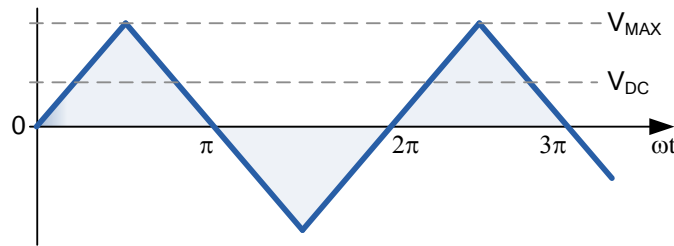

$$V_{DC} = \frac{V_{max}}{\sqrt{3}} = 0.577 V_{max}$$

$$\text{Crest Factor} = \sqrt{3}$$

$$\text{Form Factor} = \frac{2}{\sqrt{3}} = 1.155$$

1.9 SAWTOOTHED WAVEFORMS

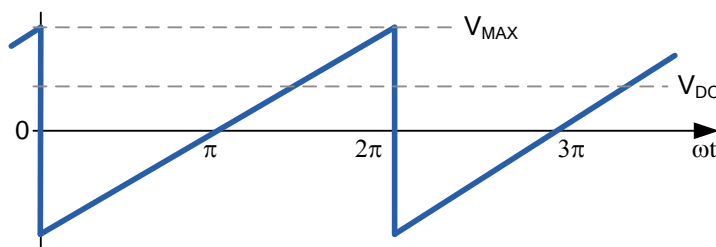

$$V_{DC} = \frac{V_{max}}{\sqrt{3}} = 0.577 V_{max}$$

$$\text{Crest Factor} = \sqrt{3}$$

$$\text{Form Factor} = \frac{2}{\sqrt{3}} = 1.155$$

1.10 TRIGGER PULSE

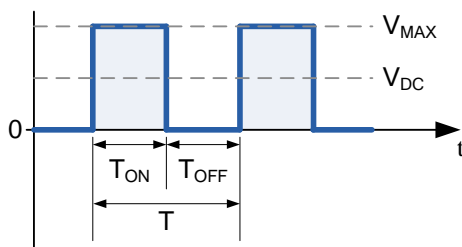

$$V_{DC} = V_{MAX} \times \frac{T_{ON}}{T}$$

$$V_{RMS} = V_{MAX} \times \sqrt{\frac{T_{ON}}{T}}$$

$$f = \frac{1}{T} \text{ (Hz)} \quad T = T_{ON} + T_{OFF}$$

$$\text{Duty Cycle} = \frac{T_{ON}}{T}$$

Not all alternating voltage waveforms are sine waves. There are also square waves, asymmetrical triangle, rectangular and complex waveforms. Complex waveforms generally consist of base fundamental waveform plus various harmonics superimposed on top. The exact appearance of a complex waveform will depend on the frequencies, magnitudes, and phase relationships of the voltage waves superimposed upon the fundamental wave.

Note that the terms **wave** and **waveform** do not refer to the same thing as a wave is a varying voltage or current, but a waveform is a graphical representation of such a varying voltage or current.

For more information visit our website at: www.electronics-tutorials.ws

Basic Electronics Tutorials

2.0 RESISTANCES AND THEIR CIRCUITS

2.1 RESISTANCE

The current flowing in an electrical circuit not only depends upon the voltage pushing this current around but also on the resistance of the wires, connections and components that make up the circuit. **Resistance**, (**R**) of a circuit is its ability to resist or prevent the flow of current (electron flow) through itself making it necessary to apply a greater voltage to the electrical circuit to cause the current to flow again. Resistance opposes current flow.

The amount of resistance a circuit element has determines whether the element is a "good conductor" with low resistance, or a "bad conductor" (insulator) with high resistance or somewhere in between.

Low resistance, for example one ohm or less implies that the circuit is a good conductor made from materials with lots of free electrons in its valence shell. Examples of good conductors are generally metals such as copper, aluminium, gold, silver or non-metals such as carbon, mercury and some acids and salts.

High resistance, one mega-ohm or more implies the circuit is a bad conductor of electricity made from insulating materials with no free electrons, or tightly grouped electrons in its valence shell. Examples of insulators include glass, porcelain, rubber, pvc (polyvinyl chloride) plastics, mineral oils and dry wood or paper, etc.

Resistance is the opposition to current flowing around an electrical circuit. The unit of resistance is the Ohm

Copper Cable

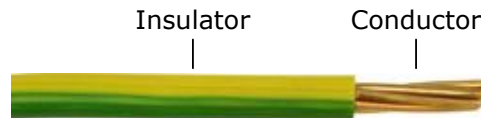

2.2 UNIT OF RESISTANCE

The SI unit of resistance is the **Ohm** with Greek symbol Ω (Omega). A conductor is said to have a resistance of one ohm when one volt causes one ampere of current to flow through it. Note that Resistance cannot be negative in value only positive and in AC circuits, AC resistance equals DC resistance, $Z_R = R$.

Prefixes used for Ohms

Prefix for Ohms	Description	Abbreviation	Value
Mega-Ohm	One Million	$M\Omega$	$10^6 \Omega$
Kilo-Ohm	One Thousand	$k\Omega$	$10^3 \Omega$
Ohm	One	Ω	$10^0 \Omega$
Milli-Ohm	One Thousandth	$m\Omega$	$10^{-3} \Omega$
Micro-Ohm	One Millionth	$\mu\Omega$	$10^{-6} \Omega$

The most common prefixes used are: **Kilo-ohms** ($k\Omega = 10^3\Omega$) and **Mega-ohms** ($M\Omega = 10^6\Omega$).

Basic Electronics Tutorials

2.3 FACTORS AFFECTING ITS RESISTANCE

1. Length of Material: The resistance of a material is directly proportional to its length. The longer the material the more resistance it has.
2. Cross-sectional Area: The resistance of a material is indirectly proportional to its width. The wider or thicker the material is the less resistance it has allowing more free electrons to flow.
3. Type of Material: The type of material affects the amount of free electrons able to flow through it. A material which is a conductor has less resistance while a material which is an insulator has more resistance.
4. Temperature: The temperature of the material affects its resistance. Some materials such as thermocouples and thermistors are design to change their resistance with temperature.

Then the resistance of any material which has a uniform cross-sectional area, **A** and length, **ℓ** can be represented in mathematical form as:

$$R = \rho \frac{\ell}{A}$$

Where: ρ is known as the **resistivity** of the material in ohm-meters

The circuit element used to model this current resisting behaviour of a material is called a **resistor**. The resistor is the simplest passive element used in Electrical and Electronic circuits that is they contain no source of power or amplification but only attenuate or reduce the voltage or current signal passing through them. The circuit symbols used to show a resistor in schematic diagrams are given below, where **R** stands for the resistance of the resistor, in this case 100Ω 's.

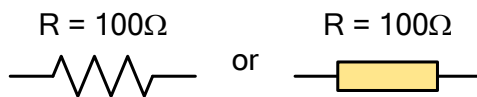

The symbol used in schematic and electrical drawings for a Resistor can either be a "zig-zag" type line or a rectangular box.

A resistor can either be fixed or variable. Most resistors are of the fixed type, meaning their resistance remains constant.

Resistor Symbols

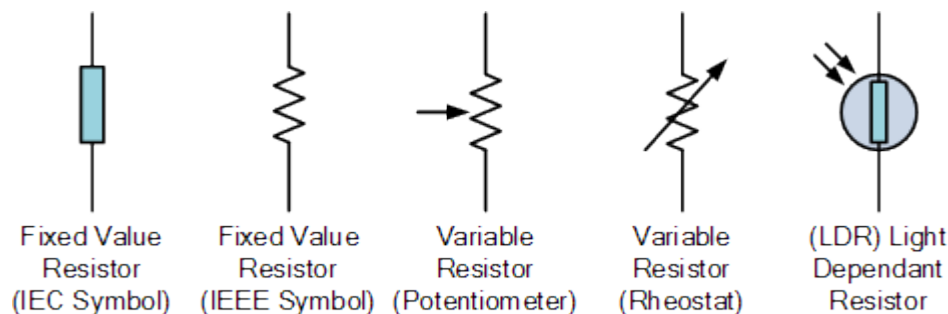

Basic Electronics Tutorials

The two most common types of fixed resistors are wirewound and carbon composition. Carbon composition resistors are used when large resistance is needed while wirewound resistors with their metal finned body are used for very high wattage applications. Variable resistors, called potentiometers or rheostats can be either linear or logarithmic types having an adjustable resistance value from zero ohms to their maximum resistance.

2.4 OHMS LAW

The relationship between Voltage, Current and Resistance in any DC electrical circuit was firstly discovered by the German physicist **Georg Ohm**. **Georg Ohm** found that, at a constant temperature, the electrical current flowing through a fixed linear resistance is directly proportional to the voltage applied across it, and also inversely proportional to the resistance.

This relationship between the Voltage, Current and Resistance forms the bases of **Ohms Law** and is shown below.

$$\text{Current (I)} = \frac{\text{Voltage (V)}}{\text{Resistance (R)}} \text{ in Amperes (A)}$$

Ohms Law states that a voltage, V across a resistor, R is directly proportional to the current, I flowing through the same resistor

By knowing any two values of the Voltage, Current or Resistance quantities we can use **Ohms Law** to find the third missing value. **Ohms Law** is used extensively in electronics formulas and calculations so it is "very important to understand and accurately remember these formulas".

To find the Voltage, (V)

$$[V = I \times R] \quad V \text{ (volts)} = I \text{ (amps)} \times R \text{ (}\Omega\text{)}$$

To find the Current, (I)

$$[I = V \div R] \quad I \text{ (amps)} = V \text{ (volts)} \div R \text{ (}\Omega\text{)}$$

To find the Resistance, (R)

$$[R = V \div I] \quad R \text{ (}\Omega\text{)} = V \text{ (volts)} \div I \text{ (amps)}$$

A resistor (or resistance) which obeys the above rules of Ohm's law is known as a *linear* resistor. Linear resistors have a constant resistance for all values of positive or negative voltages and currents. This linear relationship gives a current-voltage (I-V) characteristic of a straight line. A *nonlinear* resistor does not obey Ohm's law and will therefore have a non-straight I-V curve.

For more information visit our website at: www.electronics-tutorials.ws

Basic Electronics Tutorials

2.5 RESISTOR POWER

The unit of electrical **power** is the **Watt (W)**. One watt of power is equal to the work done in one second by one volt of potential difference in moving one coulomb of charge around a circuit. As an ampere is equal to one coulomb per second, electrical power therefore equals the product of volts times amperes, **P = VxI**

A resistor can be used at any combination of voltage (within reason) and current so long as its "Dissipating Power Rating" is not exceeded. The **power rating** of a resistor, also called its "wattage" rating, is an indication how much heat a resistor or resistive element can safely dissipate or convert into heat before becoming damaged. If more heat is generated by the resistor than can be dissipated, the resistor will overheat and become damaged. Resistor power rating is specified in watts.

$$\text{Power, (P)} = V \times I = I^2 \times R = \frac{V^2}{R} \text{ Watts}$$

Where: **V** is the voltage across the resistor, **R** in ohms, producing the current, **I** in amperes, for power, **P** in watts.

When calculating the power in resistors or resistances, the main equation to use whenever there is current flowing in the resistance is **I²R**.

The physical size of a resistor is no indication of its resistance as a small resistor can have a very low or a very high resistance value. A resistor's physical size, however, does give some indication of its power rating. As the dissipated resistor power rating is linked to their physical size, a 1/4 (0.250)W resistor is physically smaller than a 1W resistor, and resistors that are of the same ohmic value are also available in different power or wattage ratings. Carbon and metal film resistors, for example, are commonly made in wattage ratings of 1/8 (0.125)W, 1/4 (0.250)W, 1/2 (0.5)W, 1W, and 2 Watts.

Generally speaking the larger their physical size the higher its wattage rating. However, it is always better to select a particular size resistor that is capable of dissipating two or more times the calculated power. When resistors with higher wattage ratings are required, wirewound resistors fitted to metal heatsinks are generally used to dissipate the excessive heat.

Whenever current flows through a resistor heat is produced which represents electrical power in Watts

When selecting or replacing a resistor for a circuit, first determine the required resistance value using $R = V/I$, then calculate the amount of power that will be dissipated by the resistor using any one of the power formulas above. When selecting the appropriate resistor for a circuit, always try to select a resistor with a higher wattage rating than the actual calculated power dissipation for safety reasons as resistors that conduct lots of current can become very hot.

2.6 RESISTOR COLOUR CODES

Small resistors use coloured painted bands which represent a number and multiplier to indicate both their resistive value and their tolerance with the physical size of the resistor indicating its wattage rating. These coloured painted bands produce a system of identification generally known as a **Resistors Colour Code**.



4 Coloured Bands

Basic Electronics Tutorials

Resistor Colour Code Table

<u>Colour</u>	<u>Digit</u>	<u>Multiplier</u>	<u>Tolerance</u>
Black	0	1	
Brown	1	10	± 1%
Red	2	100	± 2%
Orange	3	1,000	
Yellow	4	10,000	
Green	5	100,000	± 0.5%
Blue	6	1,000,000	± 0.25%
Violet	7	10,000,000	± 0.1%
Grey	8		
White	9		
Gold		0.1	± 5%
Silver		0.01	± 10%
None			± 20%

There are two resistor colour coded systems, the four-band system and the five-band system, which use coloured bands or rings that completely encircle its body to identify the resistors value. These coloured bands are usually printed towards one end of the resistors body to indicate the first digit with the colours being read from left to right.

In the four-band system, the first band closest to the edge represents the first digit of the resistance value, the second band is the second digit, the third band is the decimal multiplier, which tells us how many zeros to add after the first two digits and the fourth band is the tolerance giving *Digit, Digit, Multiplier, Tolerance*. Resistors having standard tolerance value of 20% usually do not have a fourth band.

The five-band system displays the coloured bands the same as for the four-band, except for an additional third coloured band to represent a third significant digit giving, *Digit, Digit, Digit, Multiplier, Tolerance*. The five-band system is used for high precision resistors with low tolerance.

Preferred Values of E6, E12 and E24 Series Resistors

E6	1.0			1.5				2.2				
E12	1.0	1.2	1.5	1.8	2.2	2.7						
E24	1.0	1.1	1.2	1.3	1.5	1.6	1.8	2.0	2.2	2.4	2.7	3.0

E6	3,3			4,7				6,8				
E12	3,3	3,9	4,7	5,6	6,8	8,2						
E24	3,3	3,6	3,9	4,3	4,7	5,1	5,6	6,2	6,8	7,5	8,2	9,1

Basic Electronics Tutorials

2.7 CONNECTING RESISTORS TOGETHER

Individual resistors can be connected together in series connections, a parallel connections or combinations of both series and parallel together to produce more complex resistor networks. These resistive networks have an equivalent resistance which is a combination of the individual resistors. Then complicated resistor networks can be replaced by a single equivalent resistor, $R_{(EQUIVALENT)}$. It makes no matter what the combination or complexity of the resistor network is, all resistors obey the same basic rules defined by [Ohm's Law](#) above.

2.8 RESISTORS IN SERIES

Resistors are said to be connected in "**Series**", when they are daisy chained together in a single line. Since all the current flowing through the first resistor has no other way to go it must also pass through the second resistor and the third and so on. Resistors in series have a **Common Current** flowing through them as the current that flows through one resistor must also flow through the others as it can only take one path. Then: $I_{R1} = I_{R2} = I_{R3} = I_{R4}$ etc.

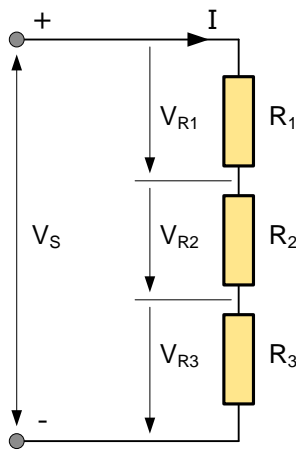

$$R_T = R_1 + R_2 + R_3 + \dots$$

$$V_S = V_{R1} + V_{R2} + V_{R3} + \dots$$

$$I = \frac{V_S}{R_T} = \frac{V_{R1}}{R_1} = \frac{V_{R2}}{R_2} = \frac{V_{R3}}{R_3}$$

2.9 VOLTAGE DIVIDER NETWORKS

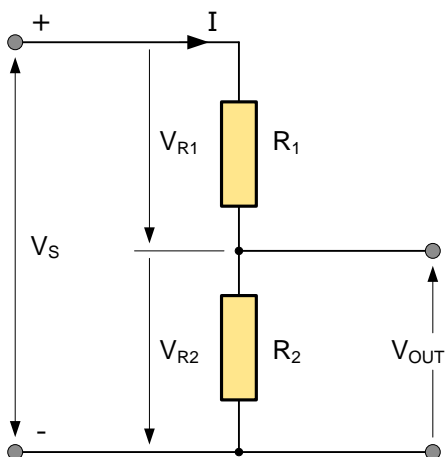

$$R_T = R_1 + R_2$$

$$V_S = V_{R1} + V_{R2}$$

$$V_{OUT} = V_S \frac{R_2}{R_T} = V_S \frac{R_2}{R_1 + R_2}$$

For more information visit our website at: www.electronics-tutorials.ws

Basic Electronics Tutorials

2.10 RESISTORS IN PARALLEL

Resistors are said to be connected together in "**Parallel**" when both of their terminals are respectively connected to each terminal of the other resistor or resistors. Unlike the previous series circuit, in a parallel resistor network the current can take more than one path.

Since there are multiple paths for the supply current to flow through, the current is not the same at all points in a parallel circuit. However, the voltage drop across all of the resistors in a parallel resistive network is the same. Then, **Resistors in Parallel** have a **Common Voltage** across them and this is true for all parallel connected elements.

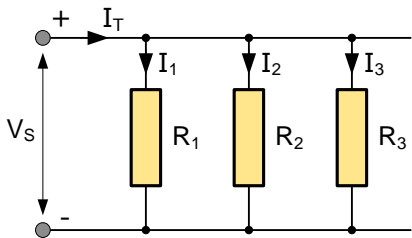

$$\frac{1}{R_T} = \frac{1}{R_1} + \frac{1}{R_2} + \frac{1}{R_3} + \dots$$
$$I_T = I_1 + I_2 + I_3 + \dots$$
$$V_S = I_{R1} = I_{R2} = I_{R3} = \dots$$

This method of calculation can be used for calculating any number of individual resistances connected together within a single parallel network. If however, there are only two individual resistors in parallel then a much simpler and quicker formula can be used to find the total resistance value, and this is given as:

2.11 TWO RESISTORS IN PARALLEL

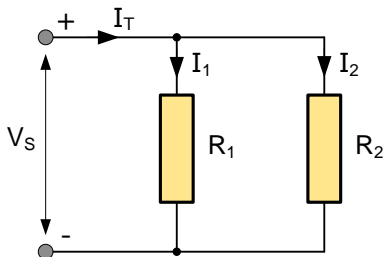

$$R_T = \frac{R_1 \times R_2}{R_1 + R_2}$$

3.0 CAPACITORS AND THEIR CIRCUITS

3.1 CAPACITANCE

Capacitors, C are also simple passive devices. The capacitor is a component which has the ability or "capacity" to store energy in the form of an electrical charge producing a potential difference across its plates. Capacitors consists of two or more parallel conductive metal or foil plates which are not connected or touching each other, but are electrically separated either by air or by some form of insulating material such as paper, mica, ceramic or plastic and which is commonly called the capacitors **Dielectric**.

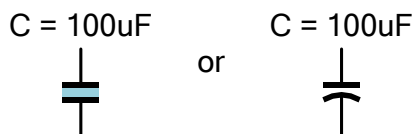

The symbol used in schematic and electrical drawings for a Capacitor can either be a two parallel lines or a straight and curved line.

Basic Electronics Tutorials

A capacitor's ability to become charged by a voltage and then hold that charge indefinitely allows capacitors to be used in electrical and electronic circuits in a variety of ways, from smoothing out fluctuations in voltage power supply levels to timing and filter circuits when used in conjunction with a resistor.

Capacitor Symbols

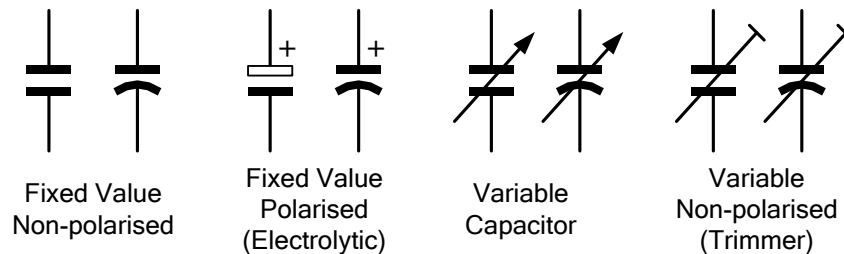

When the plates of a capacitor are connected across a DC supply voltage, it takes some time for the charge (in the form of electrons) on the plates to reach their full intensity. When a sufficient amount of charge, **Q** (measured in units of coulombs) have been transferred from the source voltage to the capacitor's plates, the voltage across the plates, V_c will be equal to the source voltage, V_s and the flow of electrons will cease.

The voltage developed across the capacitor's plates is not instantaneous but builds up slowly at a rate that depends on the capacitance value of the plates, the greater the capacitance, the slower the rate of change of voltage in the plates.

The material used to separate the plates of a capacitor from each other is called the dielectric

The capacitance, **C** value of a capacitor is an expression of the ratio between the amount of charge flowing and the rate of voltage change across the capacitor's plates. A capacitance of one **farad, F**, represents a charging current of one ampere when there is a voltage, **V** increase or decrease at a rate of one volt per second. Then one coulomb of charge exists when a capacitance of one farad is subjected to one volt of potential difference and for a parallel plate capacitor the ratio of $Q \div V$ is a constant called the capacitance, **C** as shown.

$$Q = VC, \quad C = Q \div V, \quad V = Q \div C$$

Where: **V** in volts, **Q** in coulombs and **C** in farads. Note that when **C** is given in microfarads, (μF) and **V** in volts, charge **Q** will be in micro-coulombs (μC).

3.2 UNIT OF CAPACITANCE

The SI unit of capacitance is the **Farad** (abbreviated to **F**) named after the British physicist Michael Faraday and is defined as a capacitor has the capacitance of **One Farad** when a charge of **One Coulomb** is stored on the plates by a voltage of **One volt**. Capacitance, **C** is always positive and has no negative units. However, the Farad is a very large unit of measurement to use on its own so sub-multiples of the Farad are generally used such as micro-farads, nano-farads and pico-farads, for example.

Prefixes used for Ohms

Microfarad (μF) $1\mu\text{F} = 1/1,000,000 = 0.000001 = 10^{-6} \text{ F}$

Nanofarad (nF) $1\text{nF} = 1/1,000,000,000 = 0.000000001 = 10^{-9} \text{ F}$

Picofarad (pF) $1\text{pF} = 1/1,000,000,000,000 = 0.000000000001 = 10^{-12} \text{ F}$

Basic Electronics Tutorials

3.3 CAPACITOR TYPES

The names that are used to describe the different types of capacitors are the names of the dielectric materials used in its construction, because the performance of a capacitor is usually dependant upon the type of material that is used for its dielectric. Also like resistors, there are also variable types of capacitors which allow us to vary their capacitance value for use in radio or "frequency tuning" type circuits.

The various types of capacitors include, disc and tubular ceramics made from aluminium oxide or titanium oxide, silvered mica, metallised film made using strips of waxed or oiled paper and aluminium foil, or with plastic dielectrics such as polyethylene, mylar, polypropylene, polycarbonate, and polyester, and finally large electrolytic capacitors in the form of Aluminum Electrolytic Capacitors and Tantalum Electrolytic Capacitors either polarised or non-polarised.

Variable capacitors change value due to the variation in the overlapping area of the plates, or by varying the spacing between parallel plates. Air dielectric is used for the larger capacitance values. Trimmers and smaller variable types use very thin mica or plastic sheets as the dielectric between the plates.

3.4 CONNECTING CAPACITORS TOGETHER

Like resistors, capacitors can be connected in series, parallel, and series-parallel combinations. Placing capacitors in series effectively increases the thickness of the dielectric, decreases the total capacitance. The total capacitance of capacitors in series is calculated like the total resistance of parallel resistors.

Connecting capacitors together in parallel effectively increases the area of the plates making the total capacitance equal to the sum of the individual capacitances like the total resistance of series resistors. Capacitors in parallel all charge to the same voltage.

3.5 CAPACITORS IN PARALLEL

Capacitors are said to be connected together "in parallel" when both of their terminals are respectively connected to each terminal of the other capacitor or capacitors. The voltage, V_s connected across all the capacitors that are connected in parallel is the same. Then, **Capacitors in Parallel** have a common voltage supply across them.

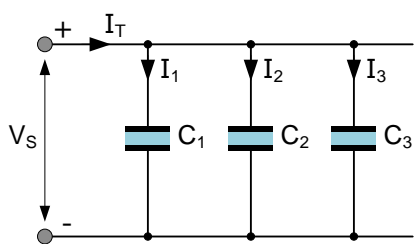

$$C_T = C_1 + C_2 + C_3 + \dots$$

$$Q_T = Q_1 + Q_2 + Q_3 + \dots$$

$$I_T = I_{C1} + I_{C2} + I_{C3} + \dots$$

$$V_C = V_s = \frac{Q_T}{C_T} = \frac{Q_1}{C_1} = \frac{Q_2}{C_2} = \frac{Q_3}{C_3} = \dots$$

3.6 CAPACITORS IN SERIES

Capacitors are said to be connected together "in series" when they are effectively "daisy chained" together in a single line. The charging current (I_C) flowing through the capacitors is **THE SAME** for all capacitors as it only has one path to follow. Then, **Capacitors in Series** all have the same current so each capacitor stores the same amount of charge regardless of its capacitance. Capacitors connected together in series all have the same amount of charge.

For more information visit our website at: www.electronics-tutorials.ws

Basic Electronics Tutorials

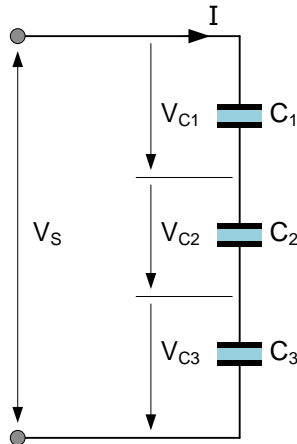

$$\frac{1}{C_T} = \frac{1}{C_1} + \frac{1}{C_2} + \frac{1}{C_3} + \dots$$

$$V_S = V_{C1} + V_{C2} + V_{C3} + \dots$$

$$Q = V_S C_T = V_1 C_1 = V_2 C_2 = V_3 C_3 = \dots$$

$$I_T = I_{C1} = I_{C2} = I_{C3} = \dots$$

4.0 INDUCTORS AND THEIR CIRCUITS

4.1 INDUCTANCE

When an electrical current flows through a length of wire, a magnetic field is built up around the wire conductor. The direction of this magnetic field can be thought in terms of a wood screw being screwed into the conductor in the direction of the flow of current, with the head of the wood screw being rotated in the direction of the lines of force.

If we now take this length of wire and form it into a coil of N turns, the magnetic flux surrounding the coil is increased many times over for a given coil of wire compared with the flux produced by a single straight length. Also, if the current which is flowing through the coils conductor is increased in magnitude, the magnetic flux produced around the coil will also increase in value.

However, as the strength of the magnetic flux increases, it induces a secondary voltage within the coil called a back emf (electro-motive force). Then for a coil of wire, a self-induced voltage is developed across the coil due to the change in current flowing *through* the coil. The polarity of this self-induced voltage produces a secondary current in the coil that generates another magnetic flux which opposes any changes to the original flux.

An Inductor is a coil of wire which opposes the flow of current through itself in the form of a magnetic field

In other words, the instant the main current begins to increase (or decrease) in value, there will be an opposing effect trying to limit this change. But because the coil of wire is extremely long, the current through the coil cannot change instantaneously it takes a while for the current to change due mainly to the resistance of the wire and the self-induced effects of the wire coil.

The ability of a coil to oppose any change in current is a result of the **self-inductance**, L of the coil. This self-inductance, simply called inductance, value of an inductor is measured in Henries, (H). The Henry is a large unit, so the milli-henry (mH) and the micro-henry (μ H) are more commonly used instead. Then the greater the inductance value of the coil, the slower is the rate of change of current for a given source voltage.

Then **Inductance** is the characteristic of an electrical conductor that opposes a change in current flow. An **inductor** is a device that stores energy within itself in the form of a magnetic field.

Basic Electronics Tutorials

The **Inductor**, also called a choke, is another passive type electrical component which is just a coil of wire that is designed to take advantage of this relationship by inducing a magnetic field in itself or in the core as a result of the current passing through the coil. This results in a much stronger magnetic field than one that would be produced by a simple coil of wire. Inductors can also be fixed or variable.

Inductors are mainly designed to introduce specific amounts of inductance into a circuit. They are formed with wire tightly wrapped around a solid central core which can be either a straight cylindrical rod or a continuous loop or ring to concentrate their magnetic flux. The inductance of a coil varies directly with the magnetic properties of the central core. Ferrite and powdered iron materials are mainly used for the core to increase the inductance by increasing the flux linking the coil.

Then the inductance of a coil which has a uniform cross-sectional area, **A** length, **ℓ** and coil turns, **N** can be represented in mathematical form as:

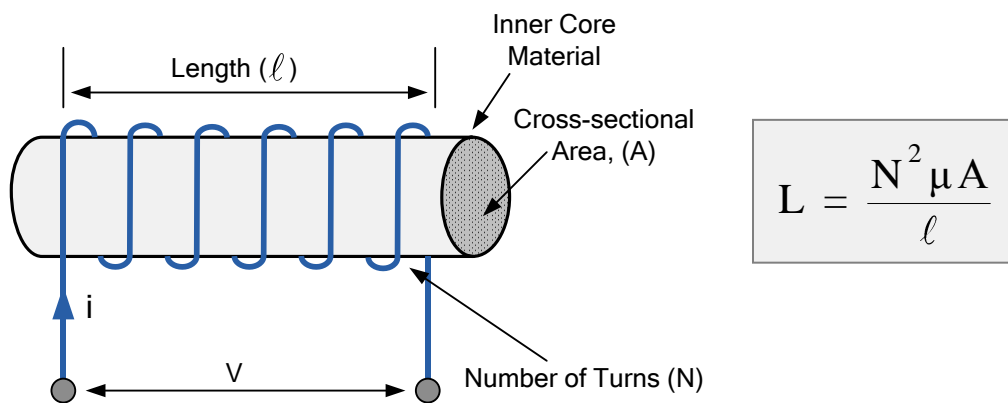

Where: **N** is the number of coil turns, **μ** is the permeability of the central core, **A** is the area in m^2 and **ℓ** is the mean length of the core in meters.

Inductor Symbols

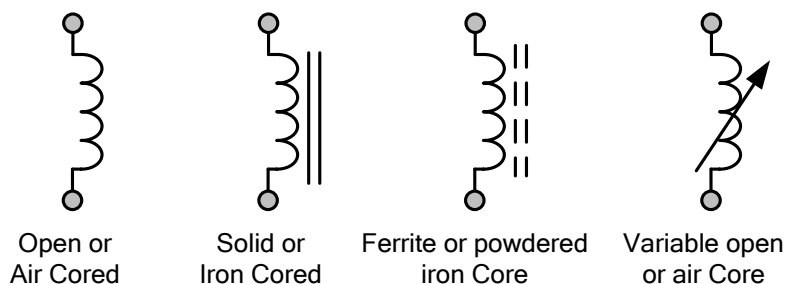

4.2 CONNECTING INDUCTORS TOGETHER

Inductors, like resistors and capacitors, can be connected together in series or parallel combinations. Increasing levels of inductance can be obtained by connecting the inductors in series, while decreasing levels can be obtained by connecting inductors in parallel. However, there are certain rules for connecting inductors in series or parallel and these are based on the fact that no mutual inductance or magnetic coupling exists between the individual inductors.

For more information visit our website at: www.electronics-tutorials.ws

Basic Electronics Tutorials

4.3 INDUCTORS IN SERIES

Inductors are said to be connected in "Series" when they are daisy chained together in a straight line, end to end. In the [Resistors in Series](#) tutorial we saw that the different values of the resistances connected together in series just "add" together and this is also true of inductance. Inductors in series are simply "added together" because the number of coil turns is effectively increased, with the total circuit inductance L_T being equal to the sum of all the individual inductances added together.

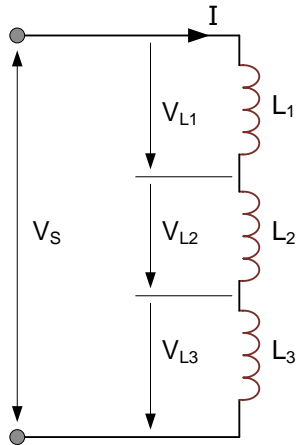

$$L_T = L_1 + L_2 + L_3 + \dots$$

$$I = I_{L1} = I_{L2} = I_{L3} + \dots$$

$$V_S = V_{L1} + V_{L2} + V_{L3}$$

4.4 INDUCTORS IN PARALLEL

Inductors are said to be connected together in "**Parallel**" when both of their terminals are respectively connected to each terminal of the other inductor or inductors. The voltage drop across all of the inductors in parallel will be the same. Then, **Inductors in Parallel** have a **Common Voltage** across them and in our example below the voltage across the inductors is given as:

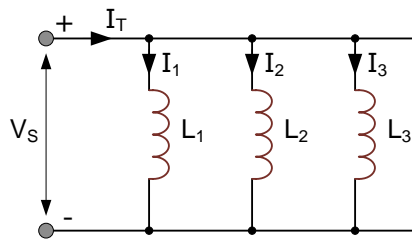

$$\frac{1}{L_T} = \frac{1}{L_1} + \frac{1}{L_2} + \frac{1}{L_3} + \dots$$

$$I_T = I_{L1} + I_{L2} + I_{L3} + \dots$$

$$V_S = V_{L1} = V_{L2} = V_{L3} = \dots$$

4.5 TWO INDUCTORS IN PARALLEL

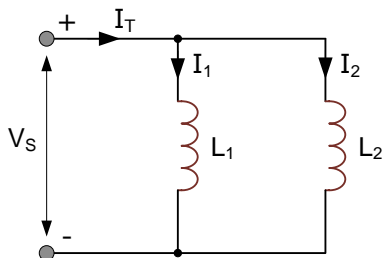

$$L_T = \frac{L_1 \times L_2}{L_1 + L_2}$$

Basic Electronics Tutorials

5.0 IMPEDANCE AND REACTANCE

5.1 IMPEDANCE

Any ideal basic circuit element such as a resistor can be described mathematically in terms of its voltage and current, and we saw previously that the voltage across a pure ohmic resistor is linearly proportional to the current flowing through it as defined by [Ohm's Law](#). If the voltage across a resistor varies sinusoidally with respect to time, as it does in an AC circuit, the current flowing through the resistor will also vary.

In an AC resistance, the current and voltage are both "in-phase" as there is no phase difference between them. The current flowing through the resistance is directly proportional to the voltage across it with their peak values related by Ohm's law.

Impedance is the opposition to sinusoidal current flow in an AC circuit being the phasor sum of both reactance and resistance

In an AC circuit, impedance represents the opposition to the flow of AC or sinusoidal current. A circuit consisting of reactance (inductive or capacitive) and a resistance will have an equivalent AC resistance known as Impedance, Z . Impedance is the phasor sum of the circuit's reactance, X and the resistance, R . Note that although impedance represents the ratio of two phasors, it is not a phasor itself, because it does not correspond to a sinusoidal varying quantity.

Impedance, which is given the letter Z , in a pure ohmic resistance is a complex number consisting only of a real part being the actual AC resistance value, (R) and a zero imaginary part, ($j0$). Because of this Ohm's Law can be used in circuits containing an AC resistance to calculate these voltages and currents. As a pure resistor has no reactance, resistance is, for all practical purposes, unaffected by the frequency of the applied sinusoidal voltage or current.

5.2 AC RESISTANCE

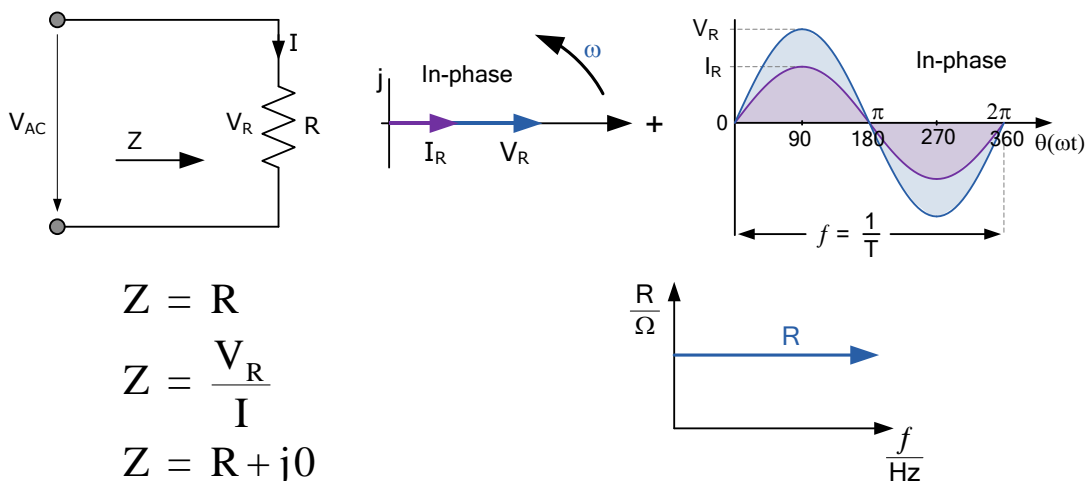

Many AC resistive circuits such as heating elements and lamps consist of a pure ohmic resistance only and have negligible values of inductance or capacitance adding to its impedance. In such circuits we can use both Ohm's Law and Kirchoff's laws as well as simple circuit rules for calculating the voltage, current, impedance and power as we would in DC circuit analysis. When working with such rules it is usual to use rms values only.

Basic Electronics Tutorials

5.3 CAPACITIVE REACTANCE

When an alternating sinusoidal voltage is applied to the plates of a capacitor, the capacitor is first charged in one direction and then again in the opposite direction, changing polarity at the same rate as the AC supply voltage. This instantaneous change in voltage across the capacitor is opposed by the fact that it takes a certain amount of time to deposit (or release) this charge onto the plates and is given by $V = Q/C$.

Capacitors oppose these changes in sinusoidal voltage with the flow of electrons through the capacitor being directly proportional to the rate of voltage change across its plates as the capacitor charges and discharges. Unlike a resistor where the opposition to current flow is its actual resistance, the opposition to current flow in a capacitor is called **Reactance**.

Like resistance, reactance is measured in Ohm's but is given the symbol "**X**" to distinguish it from a purely resistive ohmic **R** value and as the component in question is a capacitor, the reactance of a capacitor is called **Capacitive Reactance**, (X_C) which is also measured in Ohms. In an AC capacitance circuit, this capacitive reactance value, X_C is equal to $1/(2\pi fC)$ or $1/(j\omega C)$.

5.4 AC CAPACITANCE

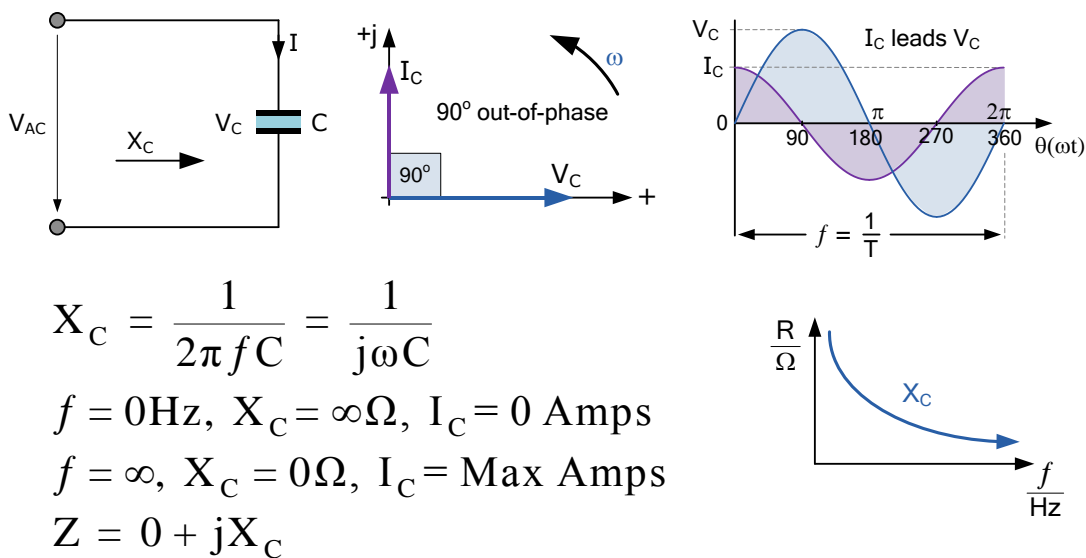

$$X_C = \frac{1}{2\pi fC} = \frac{1}{j\omega C}$$

$$f = 0\text{Hz}, X_C = \infty\Omega, I_C = 0 \text{ Amps}$$

$$f = \infty, X_C = 0\Omega, I_C = \text{Max Amps}$$

$$Z = 0 + jX_C$$

In a pure **AC Capacitance** circuit, the voltage and current are both "out-of-phase" with the current leading the voltage by 90° (or $\pi/2$ rads). So for a pure capacitor, V_C "lags" I_C by 90° , or we can say that I_C "leads" V_C by 90° .

5.5 INDUCTIVE REACTANCE

When an alternating or AC voltage is applied across an inductor the flow of current through it behaves very differently to that of an applied DC voltage. The effect of a sinusoidal supply produces a phase difference between the voltage and the current waveforms. In an AC circuit, the opposition to current flow through an inductor's coil windings not only depends upon the inductance of the coil but also the frequency of the AC waveform.

The opposition to current flowing through a coil in an AC circuit is determined by the AC resistance, more commonly known as **Impedance (Z)**, of the circuit. As the component we are interested in is an inductor, the reactance of an

For more information visit our website at: www.electronics-tutorials.ws

Basic Electronics Tutorials

inductor is therefore called "Inductive Reactance". In other words, an inductor's electrical resistance when used in an AC circuit is called **Inductive Reactance**.

Inductive Reactance which is given the symbol X_L , and is the property in an AC circuit which opposes the change in the current. In an AC inductive circuit, this capacitive reactance value, X_L is equal to $2\pi fL$ or $j\omega C$.

5.6 AC INDUCTANCE

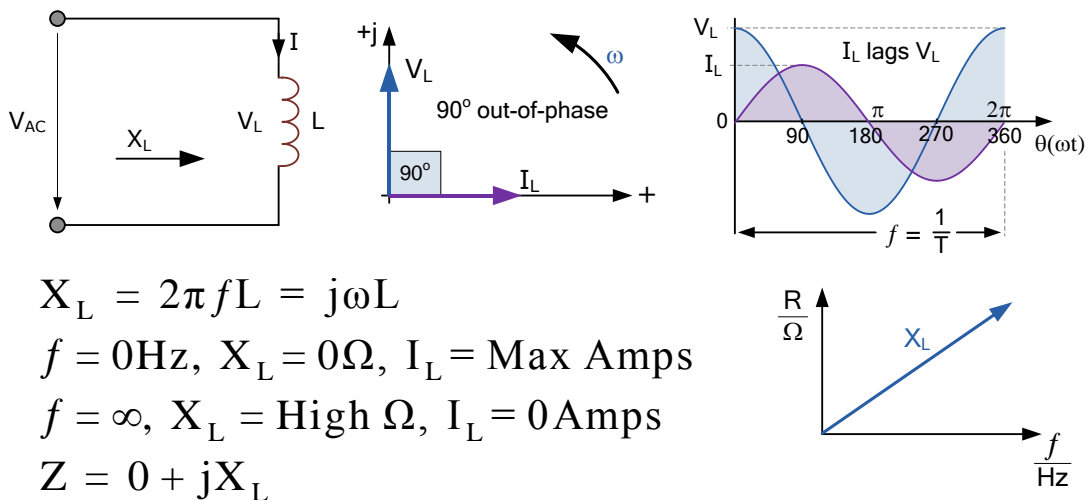

In a pure **AC Inductive** circuit, the voltage and current are both "out-of-phase" with the current lagging the applied voltage by 90° (or $\pi/2$ rads). So for a purely inductive AC circuit, V_L "leads" I_L by 90° , or we can say that I_L "lags" V_L by 90° .

6.0 RC FILTERS

RC filters are designed to modify, reshape or reject all unwanted frequencies of an electrical signal and accept or pass only those signals wanted by the circuit's designer. In other words they "filter-out" unwanted signals. Filters are named according to the frequency range of signals that they allow to pass through them, while blocking or "attenuating" the rest. The point at which a filter passes or blocks a signal is called the corner frequency, (f_c).

Ideal Filter Response

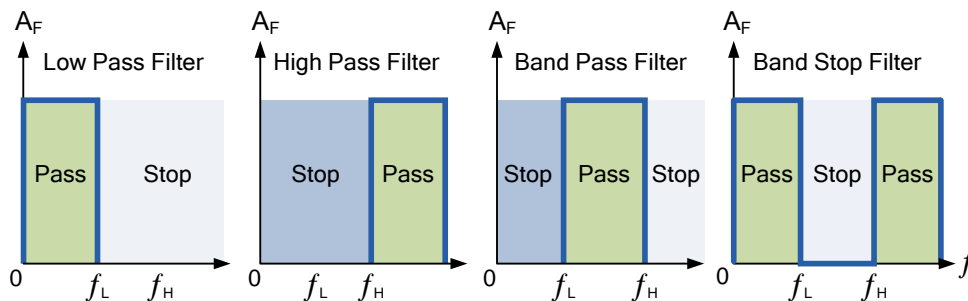

The pass band allows signals to freely pass unattenuated, while the stop band blocks all signals.

Basic Electronics Tutorials

6.1 LOW PASS RC FILTER

A low pass filter allows all low frequency signals to pass from DC (0Hz) up to its corner frequency, (f_c) and blocks all high frequency signals above this point. A first-order RC low pass filter is constructed as follows:

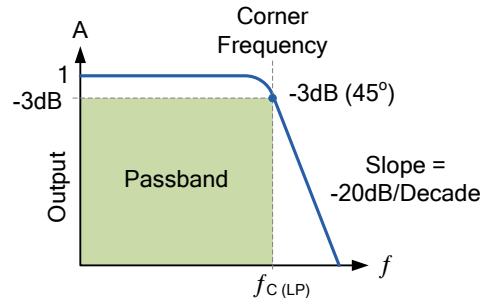
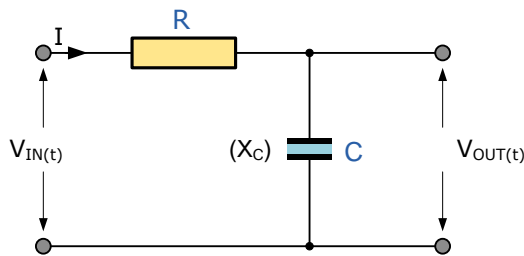

$$A = \frac{V_{OUT}}{V_{IN}} = \frac{X_C}{Z} = \frac{X_C}{\sqrt{R^2 + X_C^2}}$$

$$A = \frac{1}{\sqrt{1 + (\omega RC)^2}}$$

$$f_c = \frac{1}{2\pi RC} \quad \text{or} \quad \omega_c = \frac{1}{RC}$$

$$A_f = -3\text{dB} = \frac{1}{\sqrt{2}} = 0.7071 V_{IN}$$

Roll-off = -20dB/Decade
or -6dB/Octave

6.2 HIGH PASS RC FILTER

A high pass filter blocks all low frequency signals from DC up to its corner frequency, (f_c) and allows all high frequency signals to pass above this point. A first-order RC high pass filter is constructed as follows:

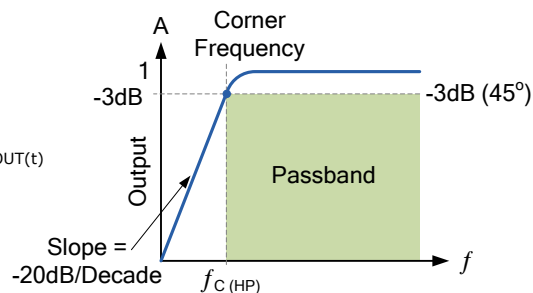
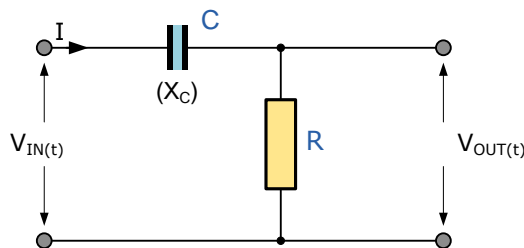

$$A = \frac{V_{OUT}}{V_{IN}} = \frac{R}{Z} = \frac{R}{\sqrt{R^2 + X_C^2}}$$

$$A = \frac{R}{\sqrt{R^2 + \left(\frac{1}{\omega C}\right)^2}}$$

$$f_c = \frac{1}{2\pi RC} \quad \text{or} \quad \omega_c = \frac{1}{RC}$$

$$A_f = -3\text{dB} = \frac{1}{\sqrt{2}} = 0.7071 V_{IN}$$

Roll-off = -20dB/Decade
or -6dB/Octave

Basic Electronics Tutorials

6.3 BAND PASS RC FILTER

A *band pass* filter blocks all low frequencies below its lower corner frequency and all high frequencies above its upper corner frequency only allowing frequency signals in between to pass. Then a band pass filter has two corner or cut-off frequencies. A second-order RC band pass filter is constructed as follows:

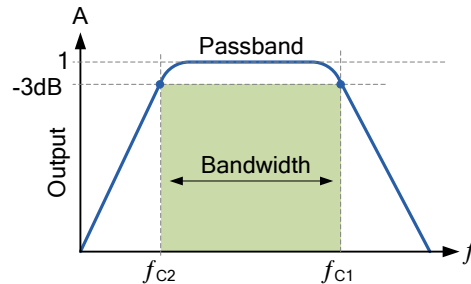
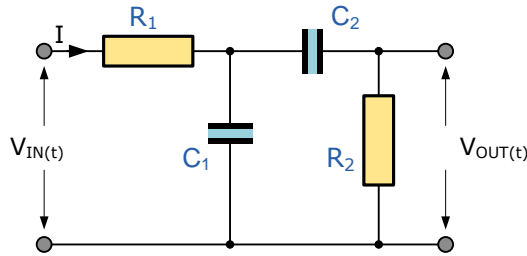

if $R_1 = R_2$ and $C_1 = C_2$

$R_1 C_1 = \text{Low Pass}$ $R_2 C_2 = \text{High Pass}$

$$f_{C1} = \frac{1}{2\pi R_1 C_1}$$

$$f_{C2} = \frac{1}{2\pi R_2 C_2}$$

$$f_C = \frac{1}{2\pi RC} \quad \text{or} \quad \omega_C = \frac{1}{RC}$$

$$f_{\text{PASSBAND}} = \sqrt{f_{C1} - f_{C2}} = \text{Bandwidth}$$

$$f_{\text{CENTER}} = \sqrt{f_{C1} \times f_{C2}}$$

$$Q = \frac{f_{\text{CENTER}}}{f_{C1} - f_{C2}}$$

6.4 BAND STOP RC FILTER

The *band stop* or *notch* filter is another filter design with two corner or cut-off frequencies. The band stop filter blocks (rejects) or severely attenuates a certain band of frequencies between its two corner frequencies while allowing all those outside of this stop-band to pass. A second-order RC band stop filter is constructed as follows:

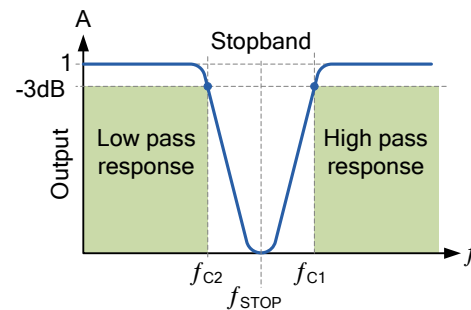
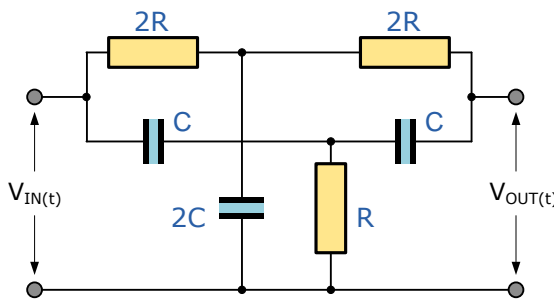

The frequency at which maximum stop attenuation occurs is given as:

$$f_{\text{STOP}} = \frac{1}{2\pi RC}$$

Basic Electronics Tutorials

7.0 SEMICONDUCTORS

Semiconductors materials such as Silicon (Si), Germanium (Ge) and Gallium Arsenide (GaAs), have electrical properties somewhere between those of a "conductor" and an "insulator". They neither are not good conductors nor are they good insulators (hence their name "semi"-conductors). They have very few "free electrons" in their valence shell because their atoms are closely grouped together in a tight crystalline pattern called a "crystal lattice". However, their ability to conduct electricity can be greatly improved by adding certain "impurities" to this crystalline structure thereby, producing more free electrons than holes or vice versa.

By controlling the amount of impurities added to the semiconductor material it is possible to control its conductivity. These impurities are called donors or acceptors depending on whether they produce electrons or holes respectively. This process of adding impurity atoms to semiconductor atoms (the order of 1 impurity atom per 10 million (or more) atoms of the semiconductor) is called **Doping**.

Silicon Atom Structure

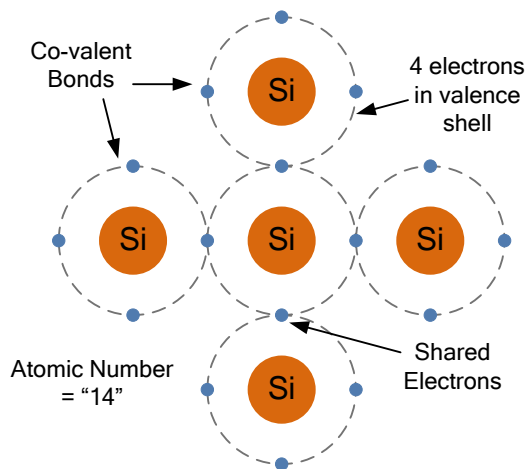

In order for a silicon crystal to conduct electricity, we need to introduce an impurity atom that has five outer electrons in its outermost valence shell to share with its neighbouring atoms. The most common type of "pentavalent" (5-electron) impurities used to dope silicon are **Antimony** (symbol Sb) or **Phosphorus** (symbol P), because they have 51 electrons arranged in five shells around their nucleus with the outermost orbital having five electrons.

The resulting semiconductor basic material has an excess of current-carrying electrons, each with a negative charge, and is therefore referred to as an **N-type** material. Then N-type Semiconductors are materials which have pentavalent impurity atoms (Donors) added and conduct by "electron" movement. In these types of materials the donors are positively charged and there are a large number of free electrons.

If we go the other way, and introduce a "trivalent" (3-electron) impurity into the crystalline structure, such as **Boron** (symbol B) or **Indium** (symbol In), which have only three valence electrons available in their outermost orbital, the fourth closed bond cannot be formed. Therefore, a complete connection is not possible, giving the semiconductor material an abundance of positively charged carriers known as "holes" in the structure of the crystal where electrons are effectively missing.

The doping of Boron atoms causes conduction to consist mainly of positive charge carriers resulting in what is called a **P-type** material. Then P-type Semiconductors are a material which have trivalent impurity atoms (Acceptors) added and conducts by the movement of "holes". In these types of materials the acceptors are negatively charged and there are a large number of holes for free electrons to fill.

Semiconductor materials made from silicon are used to produce diodes, mosfet's, bipolar transistors and all types of integrated circuits

So by using different doping agents to a base material of either Silicon (S) or Germanium (Ge), it is possible to produce different types of basic semiconductor materials, either N-type or P-type for use in electronic semiconductor components, microprocessor and solar cell applications.

For more information visit our website at: www.electronics-tutorials.ws

Basic Electronics Tutorials

The most basic semiconductor device is the diode formed from the fusing together of both N-type and P-type semiconductor materials. The semiconductor diode is a device that allows current to pass through it in only one direction. This characteristic of a diode has many useful applications in electronics such as rectification of AC voltages and currents to DC.

7.1 THE SEMICONDUCTOR DIODE

A diode is one of the simplest semiconductor devices, which has the characteristic of passing current in one direction only. However, unlike a resistor, a diode does not behave linearly with respect to the applied voltage as the diode has an exponential I-V relationship and therefore we can not described its operation by simply using an equation such as Ohm's law.

Diode I-V Characteristics

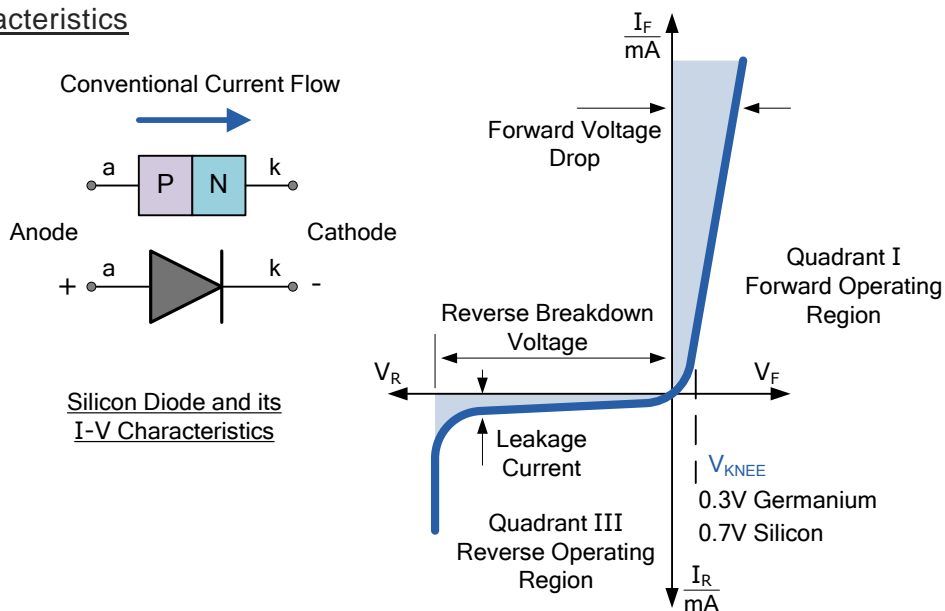

When the diode's anode terminal is more positive than its cathode terminal by at least 0.7 volts for a silicon device, the diode is classed as being "forward biased" allowing current to flow through the device. However, when the anode is made more negative than the cathode, the diode is classed as being "reversed biased" and blocks the flow of current up to its reverse breakdown voltage at which point the diode loses control.

Note that the arrow points in the direction of conventional current flow and the diodes two connections are known as the *Anode*, (A) and *Cathode*, (K). The cathode (negative end) is often marked with a band for identification.

Semiconductor diodes are formed using either Silicon or Germanium semiconductor materials. Diodes are classed as either small signal diodes for use in a variety of small voltage applications or classed as power diodes for use in rectifying and mains powered circuits. Germanium diodes, unlike silicon diodes, only require a forward-biasing voltage of 0.2 volts or greater for conduction to occur.

Diodes being one way devices cannot be connected together in series randomly. Only circuit, "A" will conduct current.

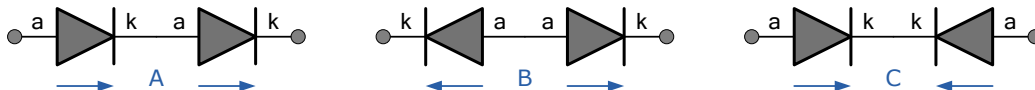

Basic Electronics Tutorials

7.2 APPLICATIONS OF DIODES

A very common application of diodes is half-wave rectification, where either the positive or negative half of the input voltage is blocked.

Half-wave Rectification

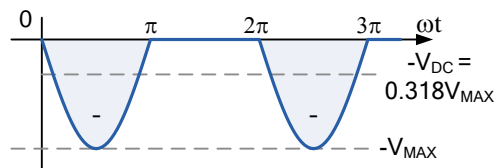
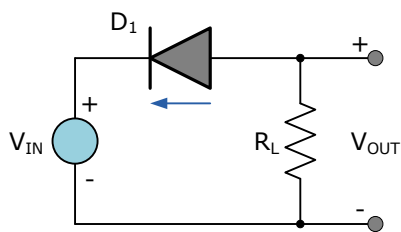
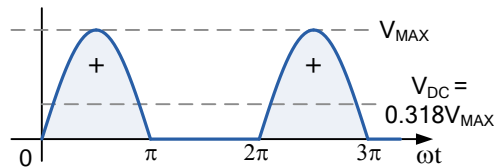
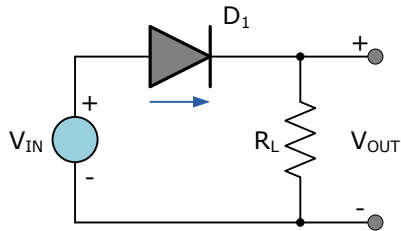

Full-wave Rectification

A full-wave rectifier passes both the negative and positive half cycles of the input, while inverting the negative half of the input. A full-wave rectifier circuit reduces the ripple by a factor of two. Also the output DC ripple is twice the input supply frequency.

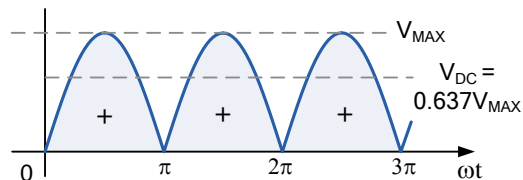
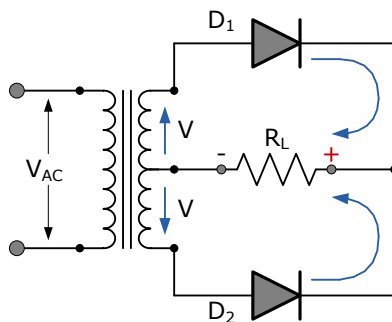

Bridge Rectifier

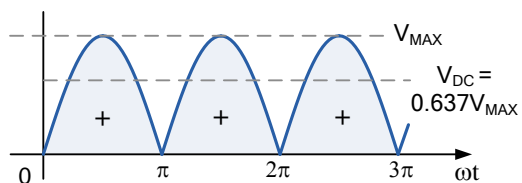
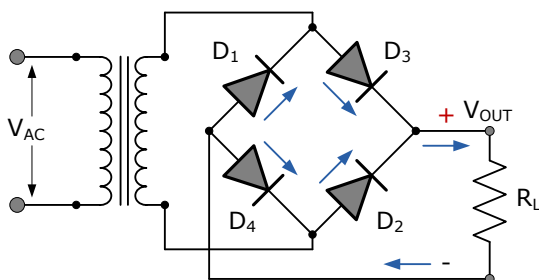

Basic Electronics Tutorials

7.3 THE ZENER DIODE

As stated previously, a semiconductor junction diode blocks the flow of current in the reverse direction. However, if we increase the reverse voltage across the diode sufficiently high enough, the diode's PN-junction will breakdown and the diode will become damaged allowing current to flow. The reverse voltage level at which this breakdown occurs is called the *breakdown voltage*, or *peak reverse voltage*.

A zener diode is a special type of diode that conducts normally in the forward-biased mode but is designed to operate in the reverse-biased mode so that at a certain breakdown voltage point, the reverse voltage causes the diode to conduct in a controlled way allowing a reverse current to flow through a series limiting resistor, (R_z). This breakdown voltage is called the **zener voltage**, (V_z).

The zener diode is a special type of diode designed to operate in the reverse bias direction and is used to stabilize or regulate a voltage

The breakdown voltage point of a zener diode, V_z is determined by the resistivity of the diodes junction which is controlled by the doping technique used during its manufacture with zener breakdown voltages ranging from 2.7V to about 200V. The voltage across the zener diode, V_z , remains reasonably constant over a wide range of reverse currents passing through the zener diode.

Zener Diode I-V Characteristics

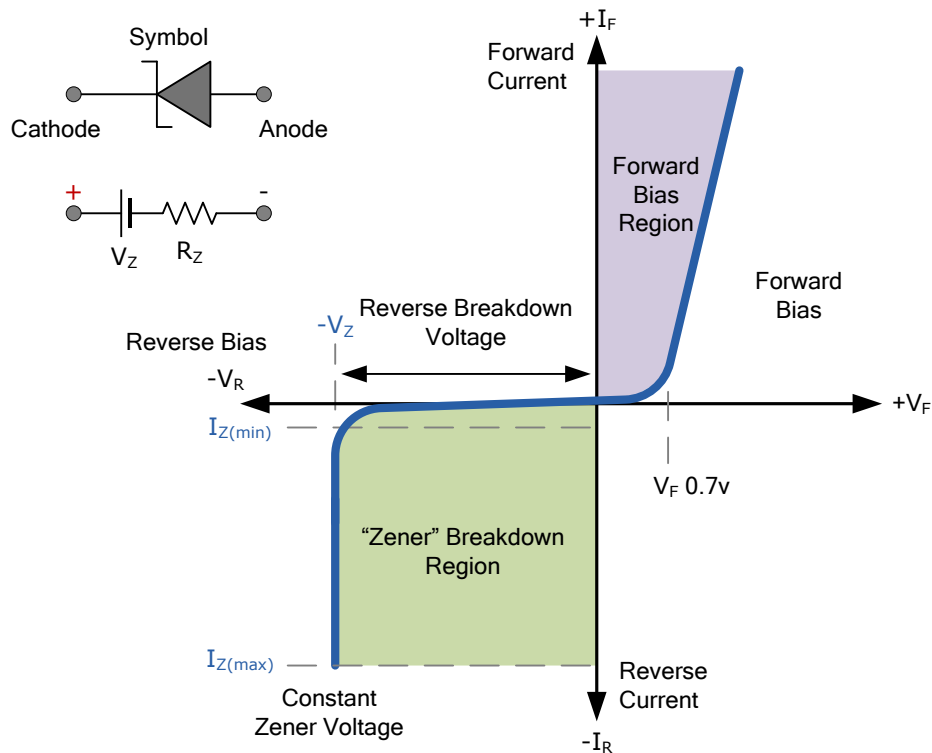

The zener diode has a region in its reverse bias characteristics of almost a constant negative voltage regardless of the value of the current flowing through the diode and remains nearly constant even with large changes in load current. This ability to control itself can be used to great effect to regulate or stabilise a voltage source against supply or load variations.

Basic Electronics Tutorials

7.4 ZENER VOLTAGE REGULATOR

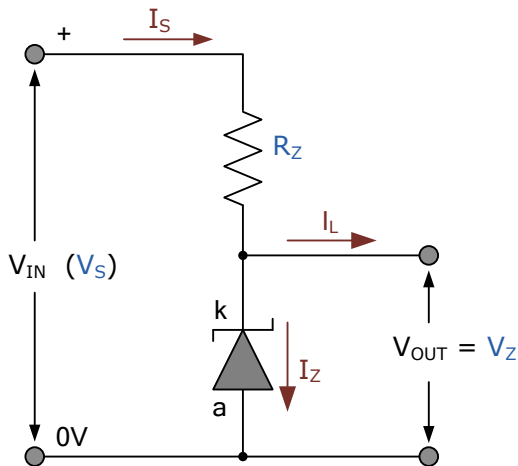

$$I_S = I_L + I_Z$$

$$R_Z = \frac{V_S - V_Z}{I_L + I_Z}$$

$$I_{Z(\text{MAX})} = \frac{V_S - V_Z}{R_Z}$$

$$P_Z = V_Z \times I_Z$$

7.5 THE BIPOLAR JUNCTION TRANSISTOR

The transistor is another electronic device made from different semiconductor materials that can act as either an insulator or a conductor by the application of a small change in current on one lead to produce a large change in voltage, current and power through the other two leads.

In electronic circuits, transistors have two basic functions: "switching" (digital electronics) or "amplification" (analogue electronics). Transistors are made by adding an additional semiconductor layer to a PN-junction diode. In fact bipolar transistors can be thought of as two diodes back-to-back.

Transistors are electronic devices that can amplify voltages, currents and power by the application of a small signal voltage on one lead

The **Bipolar Transistor** basic construction consists of two PN-junctions producing three connecting terminals with each terminal being given a name to identify it from the other two. These three terminals are known and labelled as the **Emitter (E)**, the **Base (B)** and the **Collector (C)** respectively.

Bipolar transistors are current regulating devices that control the amount of current flowing through them in proportion to the amount of biasing voltage applied to their base terminal acting like a current-controlled switch. The principle of operation of the two transistor types PNP and NPN, is exactly the same the only difference being in their biasing and the polarity of the power supply for each type.

Bipolar transistors have the ability to operate within three different regions:

- 1. Active Region** - the transistor operates as an amplifier and $I_c = \beta \cdot I_b$
- 2. Saturation Region** - the transistor is "Fully-ON" operating as a switch and $I_c = I(\text{saturation})$
- 3. Cut-off Region** - the transistor is "Fully-OFF" operating as a switch and $I_c = 0$



For more information visit our website at: www.electronics-tutorials.ws

Basic Electronics Tutorials

Bipolar Transistor Configurations

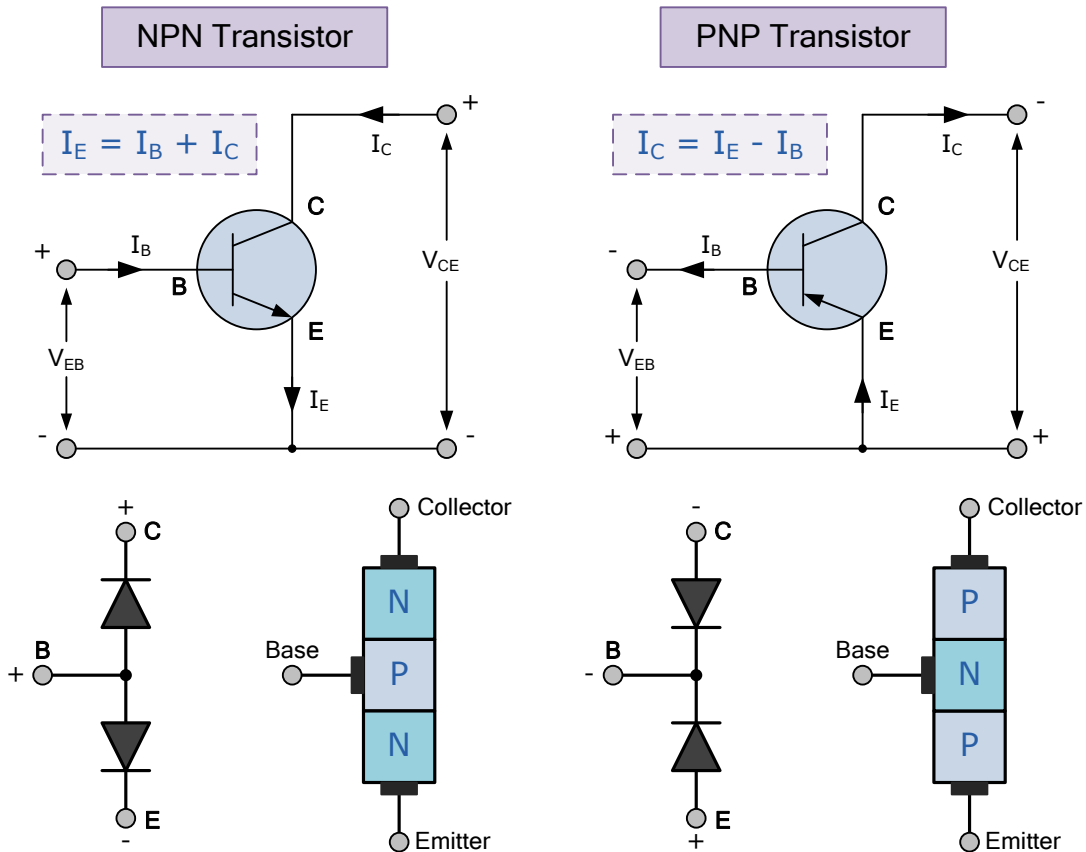

The construction and circuit symbols for both the PNP and NPN bipolar transistor are given above with the arrow in the circuit symbol always showing the direction of "conventional current flow" between the base terminal and its emitter terminal. The direction of the arrow always points from the positive P-type region to the negative N-type region for both transistor types, exactly the same as for the standard diode symbol.

Transistor Amplifier

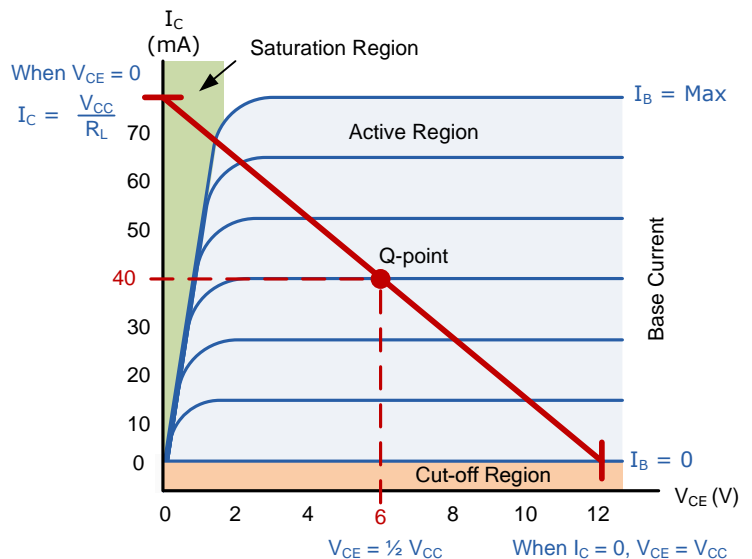
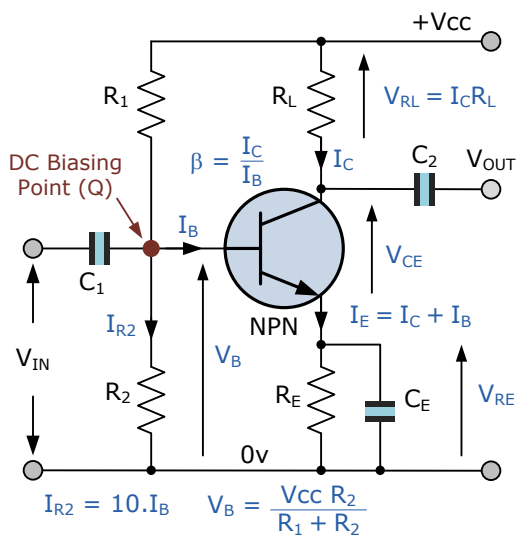

Basic Electronics Tutorials

7.6 THE FIELD EFFECT TRANSISTOR

The **Field Effect Transistor**, or **FET** is another three terminal semiconductor device used for switch and amplifier application as it has very similar characteristics to those of the previous bipolar junction transistor. The field effect transistor is a unipolar device since the flow of current through it is carried out by the majority carriers only. However, unlike the previous bipolar transistor which is a current operated device, the field effect transistor is a "voltage" operated device.

We saw previously that there are two basic types of Bipolar Transistor construction, NPN and PNP, which basically describes the physical arrangement of the P-type and N-type semiconductor materials from which they are made. This is also true of field effect transistors as there are also two basic classifications of FET, called the N-channel FET and the P-channel FET.

The **Field Effect Transistors** basic construction consists of a semiconductor "channel" which corresponds in function to the Collector and the Emitter respectively of the bipolar transistor. This resistive channel is the main current carrying path through the FET and may be made of either a P-type or an N-type semiconductor material.

Like the bipolar transistor, the FET is also a three terminal device with each terminal being given a name to identify it from the other two. These three terminals are known as the **Drain (D)**, the **Gate (G)** and the **Source (S)**.

Field Effect Transistor Configurations

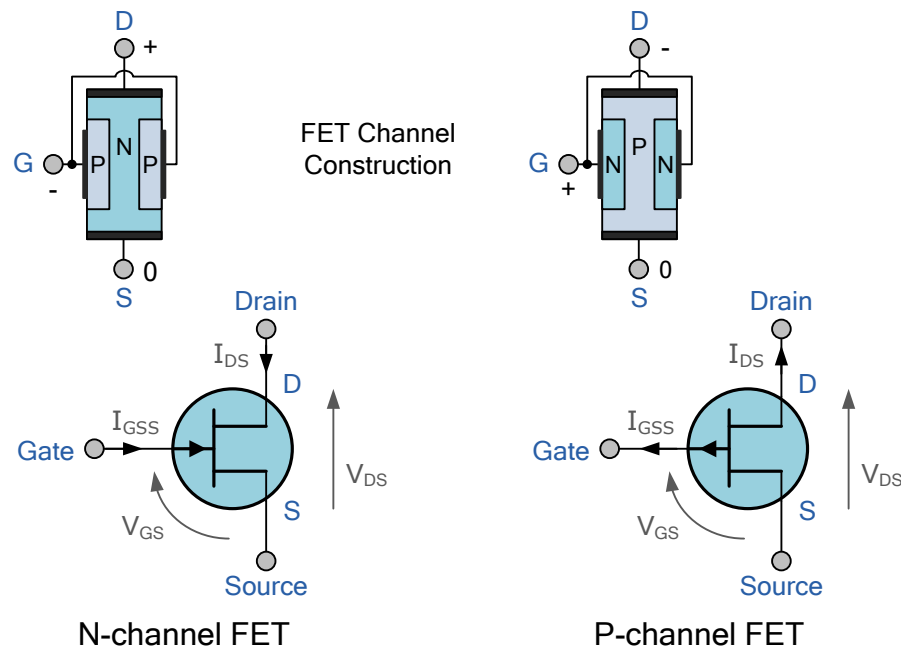

Comparison of terminals between the Field Effect Transistor and the Bipolar Junction Transistor.

Bipolar Transistor	Field Effect Transistor
Emitter - (E)	>> Source - (S)
Base - (B)	>> Gate - (G)
Collector - (C)	>> Drain - (D)

Basic Electronics Tutorials

Field Effect Transistor Amplifier

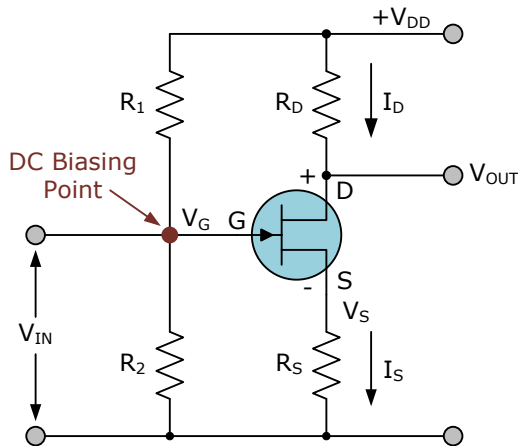

$$V_S = I_D R_S = \frac{V_{DD}}{4}$$

$$V_S = V_G - V_{GS}$$

$$V_G = V_{DD} \left(\frac{R_2}{R_1 + R_2} \right)$$

$$I_D = \frac{V_S}{R_S} = \frac{V_G - V_{GS}}{R_S}$$

The control of the Drain current by a negative Gate potential makes the **Junction Field Effect Transistor** useful as a switch and it is essential that the Gate voltage is never positive for an N-channel JFET as the channel current will flow to the Gate and not the Drain resulting in damage to the JFET. The principals of operation for a P-channel JFET are the same as for the N-channel JFET, except that the polarity of the voltages need to be reversed.

7.6 THE MOSFET

As well as the Junction Field Effect Transistor (JFET), there is another type of Field Effect Transistor available whose Gate input is electrically insulated from the main current carrying channel and is therefore called an **Insulated Gate Field Effect Transistor** or **IGFET**. The most common type of insulated gate FET which is used in many different types of electronic circuits is called the **Metal Oxide Semiconductor Field Effect Transistor** or **MOSFET** for short.

The **IGFET** or **MOSFET** is a voltage controlled field effect transistor that differs from a JFET in that it has a "Metal Oxide" Gate electrode which is electrically insulated from the main semiconductor N-channel or P-channel by a thin layer of insulating material. This insulated metal gate electrode can be thought of as one plate of a capacitor. The isolation of the controlling Gate makes the input resistance of the **MOSFET** extremely high in the Mega-ohms region.

MOSFET's are voltage controlled devices which have insulated gates resulting in an input impedance many times higher than a JFET.

As the Gate terminal is isolated from the main current carrying channel "NO current flows into the gate" and just like the JFET, the **MOSFET** also acts like a voltage controlled resistor were the current flowing through the main channel between the Drain and Source is proportional to the input voltage.

Like the previous JFET, MOSFETs are three terminal devices with a *Gate*, *Drain* and *Source* and both P-channel (PMOS) and N-channel (NMOS) MOSFETs are available. The main difference this time is that MOSFETs are available in two basic forms:

1. Depletion Type (Normally ON) - the transistor requires the Gate-Source voltage, (V_{GS}) to switch the device "OFF". The depletion mode MOSFET is equivalent to a "Normally Closed" switch.

2. Enhancement Type (Normally OFF) - the transistor requires a Gate-Source voltage, (V_{GS}) to switch the device "ON". The enhancement mode MOSFET is equivalent to a "Normally Open" switch.

Basic Electronics Tutorials

MOSFET Configurations

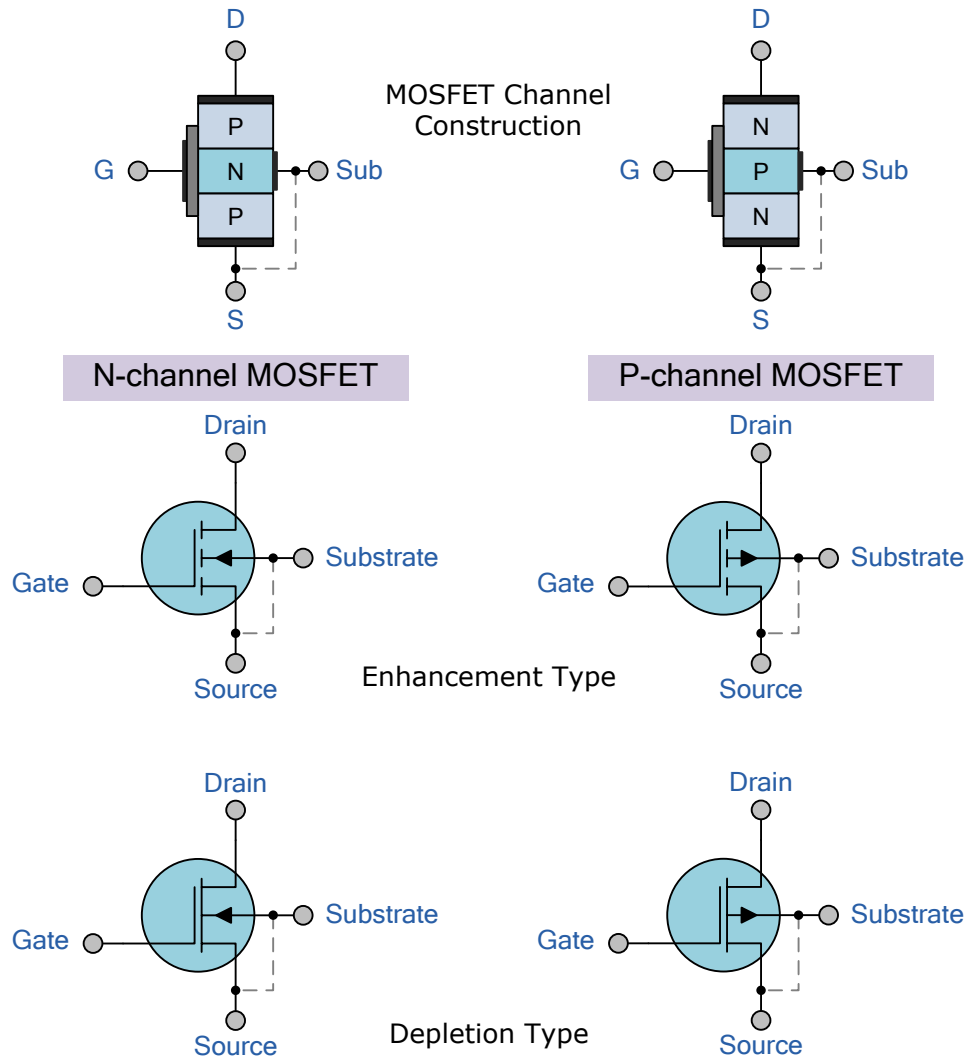

One of the main disadvantages of MOSFET devices is their very high input impedance making them extremely sensitive to electrostatic discharge (ESD) on the gate terminal. The metal oxide insulating layer around the gate terminal is extremely thin and can be easily punctured by static so be careful when handling MOSFET devices.

8.0 OPERATIONAL AMPLIFIERS

Operational Amplifiers, or "Op-amps" as they are more commonly called, are linear devices that have all the properties required for nearly ideal DC amplification and are therefore used extensively in signal conditioning, filtering or to perform mathematical operations (hence their name "operational") such as add, subtract, integration and differentiation.

An ideal **Operational Amplifier** is basically a three-terminal device which consists of two high impedance inputs, one is called the **Inverting Input**, marked with a negative or "minus" sign, (-) and the other one is called the **Non-inverting Input**, marked with a positive or "plus" sign (+). A voltage level applied to only one of these inputs will be amplified if the second input is grounded or held at some fixed voltage level.

For more information visit our website at: www.electronics-tutorials.ws

Basic Electronics Tutorials

Operational amplifiers can have infinite open-loop voltage gain allowing them to operate at their maximum amplification. However this very high open-loop gain causes the op-amp to become unstable so the gain is reduced to a more practical level by using negative feedback.

Negative feedback in electronics refers to taking a small part of the output signal from the amplifiers output and feeding it back either to aid or to oppose the input signal. Negative feedback means that the returning signal has a phase that opposes the input signal and can significantly improve the performance of an operational amplifier.

Operational amplifiers can be connected into two basic configurations, **Inverting** and **Non-inverting**.

8.1 INVERTING AMPLIFIER

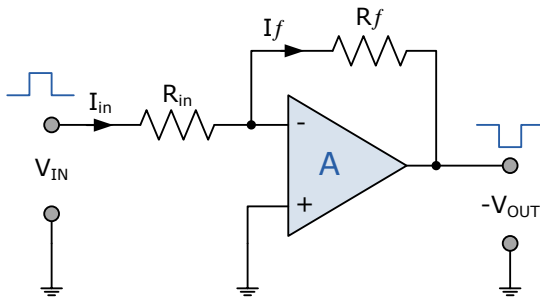

$$A_V = \frac{V_{OUT}}{V_{IN}} = -\frac{R_f}{R_{IN}}$$

$$V_{OUT} = -V_{IN} \left(\frac{R_f}{R_{IN}} \right)$$

$$Z_{IN} = R_{IN}$$

8.2 NON-INVERTING AMPLIFIER

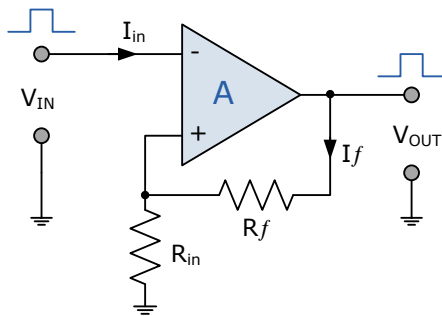

$$A_V = \frac{V_{OUT}}{V_{IN}} = 1 + \frac{R_f}{R_{IN}}$$

$$V_{OUT} = V_{IN} (A_V)$$

$$Z_{IN} = \infty$$

8.3 VOLTAGE FOLLOWER

By connecting the output directly back to the negative input terminal, 100% feedback is achieved resulting in a **Voltage Follower** (buffer) circuit with a constant gain of 1 (Unity).

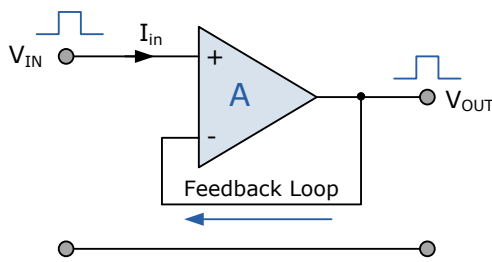

$$V_{IN} = +V, \quad V_{OUT} = -V$$

$$\therefore V_{OUT} = V_{IN}$$

$$A_V = \frac{V_{OUT}}{V_{IN}} = 1$$

$$Z_{IN} = \infty$$

Basic Electronics Tutorials

Op amps are used in a wide variety of applications and by adding more input resistors to either the inverting or non-inverting inputs, op-amp **Voltage Adders**, **Voltage Subtractors**, **Integrators** and **Differentiators** can be made.

8.4 DIFFERENTIAL AMPLIFIER (SUBTRACTOR)

The **Differential Amplifier** produces an output that is proportional to the difference between the 2 input voltages.

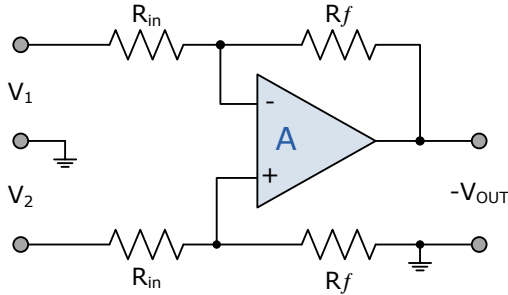

$$V_{OUT} = -\frac{R_f}{R_{IN}}(V_2 - V_1)$$

$$\therefore V_{OUT} = A(V_2 - V_1)$$

8.5 VOLTAGE SUMMING AMPLIFIER

Voltage Adders or **Summing Amplifiers** are made by adding more input resistors.

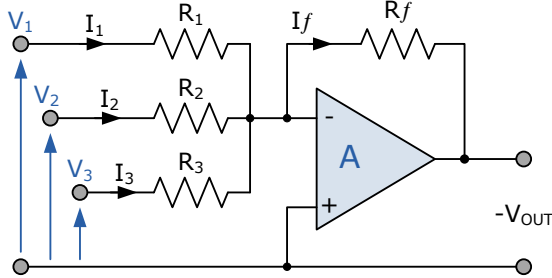

$$I_f = I_1 + I_2 + I_3 + \dots$$

$$V_{OUT} = -\left(\frac{R_f}{R_1}V_1 + \frac{R_f}{R_2}V_2 + \frac{R_f}{R_3}V_3\right)$$

$$\text{If } R_1 = R_2 = R_3$$

$$V_{OUT} = -\frac{R_f}{R_{IN}}(V_1 + V_2 + V_3 + \dots)$$

8.6 INTEGRATOR AMPLIFIER

The **Integrator Amplifier** produces an output that is the mathematical operation of integration.

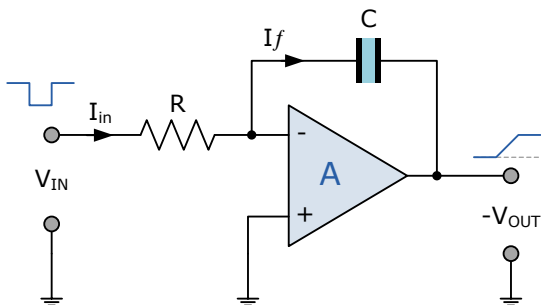

$$V_{OUT} = \frac{1}{2\pi f RC} V_{IN} \quad \text{and } \tau = RC$$

with a sinusoidal input

$$V_{OUT} = \frac{X_C}{R} = \frac{1}{2\pi f RC} \quad \text{or } \frac{1}{\omega RC}$$

$$\theta = 90^\circ$$

Basic Electronics Tutorials

8.7 DIFFERENTIATOR AMPLIFIER

The **Differentiator Amplifier** produces an output that is the mathematical operation of differentiation.

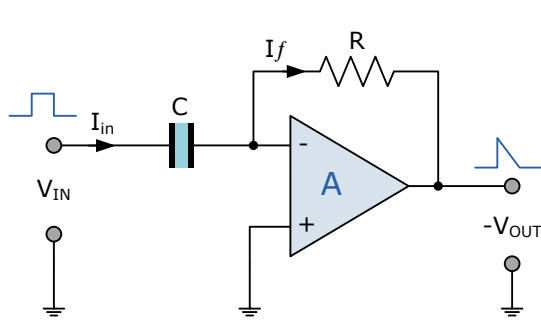

$$V_{OUT} = -\frac{dV_{IN}}{dt} RC \quad \text{and} \quad \tau = RC$$

with a sinusoidal input

$$V_{OUT} = \frac{R}{X_C} = \omega RC$$

$$\theta = -90^\circ$$

The end, for now.

I hope you found this free Electronics reference guide useful and if so please feel free to pass it on to all your Electronics friends and colleagues.

Thank you.

Wayne Storr

<http://www.electronics-tutorials.ws>

For more information visit our website at: www.electronics-tutorials.ws