

Pump Performance

EAS 199A Notes

Gerald Recktenwald
Portland State University
Department of Mechanical Engineering
gerry@me.pdx.edu

We made a pump, now we'll test it.

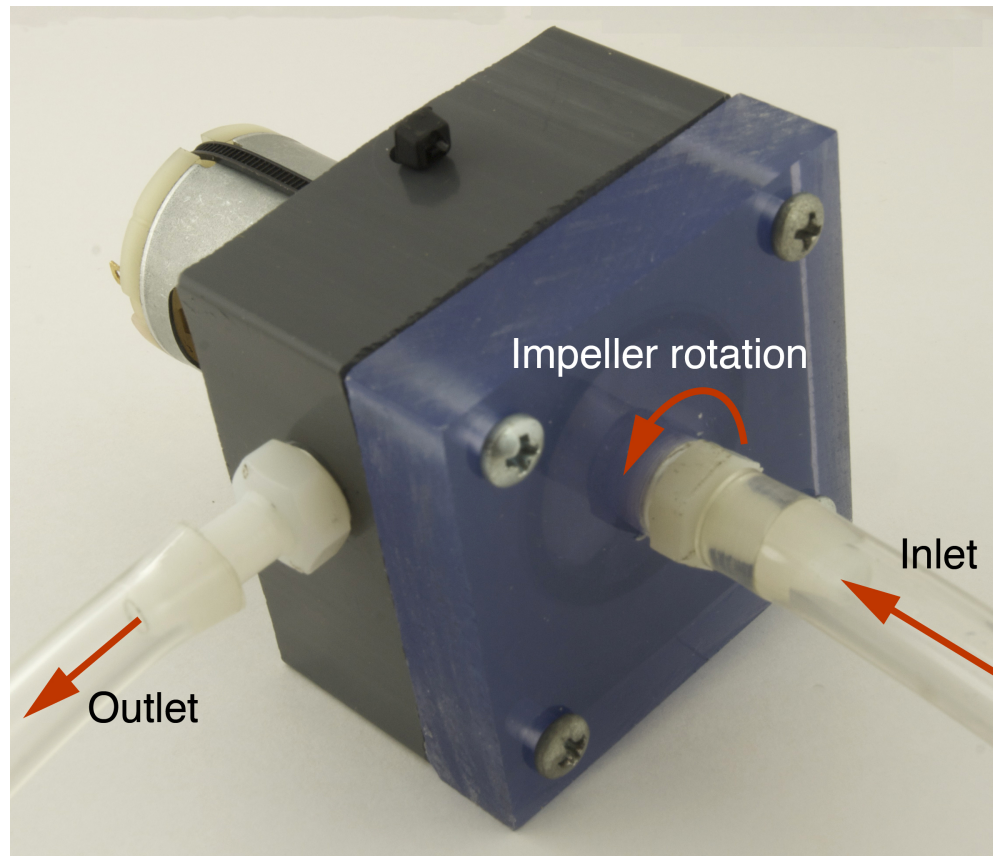

Pump Performance

The pump converts electrical power into fluid motion.

Engineers have a common language and analytical models to describe pump performance.

In any one application these parameters may be more or less important.

Flow rate, Q

Head, h

Efficiency, η

Note that Q is also used as the symbol for heat transfer.

Flow rate (1)

Consider the filling of a bucket from a faucet.

v is the downward fluid velocity

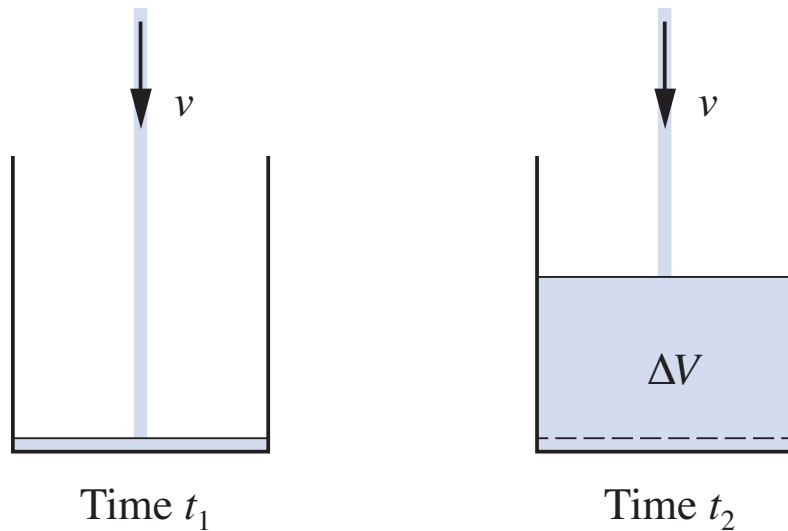

Volumetric flow rate

$$Q = \frac{\text{Volume of fluid}}{\text{Time interval}}$$
$$= \frac{\Delta V}{t_2 - t_1} = \frac{\Delta V}{\Delta t}$$

ΔV is the change in volume during the time interval $t_2 - t_1 = \Delta t$.

Flow rate (2)

Common units of volumetric flow rate are

SI	English Engineering
m^3/s	ft^3/s
L/min	ft^3/min or CFM
	gal/min or GPM

Flow rate (3)

Mass flow rate

$$\dot{m} = \frac{\text{Mass of fluid}}{\text{Time interval}} = \frac{\Delta m}{\Delta t}$$

Mass and volume are related by the fluid density, ρ

$$\text{density } \rho = \frac{\text{mass}}{\text{volume}} \implies \Delta m = \rho \Delta V$$

Therefore

$$\dot{m} = \rho Q$$

Flow rate in a tube

Consider flow from a faucet into a bucket.

The average fluid velocity is v .

In time Δt , the fluid slug moves $L = v \Delta t$.

Therefore, the volume passing an arbitrary reference point is

$$\Delta V = LA = v \Delta t A$$

where A is the cross-sectional area of the pipe.

Therefore, the volumetric flow rate is

$$Q = \frac{\Delta V}{\Delta t} = \frac{v \Delta t A}{\Delta t} = vA$$

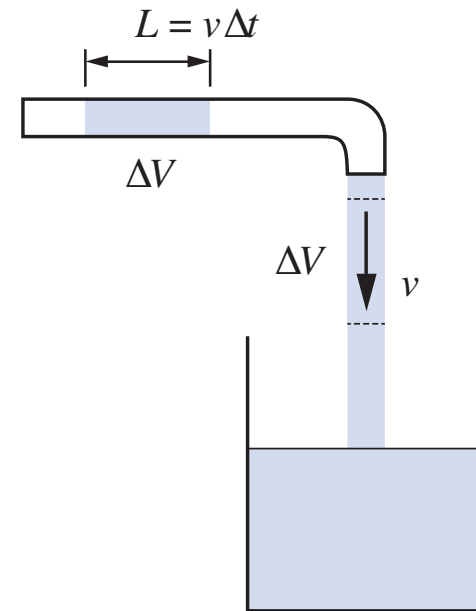

Flow rate formulas

Volumetric Flow Rate

$$Q = vA$$

where v is the average fluid velocity in the tube,
and A is the cross-sectional area of the tube.

Mass flow rate

$$\dot{m} = \rho Q = \rho v A$$

where ρ is the fluid density.

If \dot{m} is known, then the average velocity is

$$v = \frac{Q}{A} = \frac{\dot{m}}{\rho A}$$

Pump head

Head is a measure of how high the pump can push the fluid.

If the friction losses in the inlet and outlet tubes can be neglected, the head produced by the pump is equal to h , the height of the free end of the hose above the free surface of the supply reservoir.

Each pump has a characteristic relationship between head and flow rate.

- An increase in head causes a decrease in Q
- There is a maximum h for which $Q = 0$
- At $h = 0$ (no uphill) then Q is a maximum

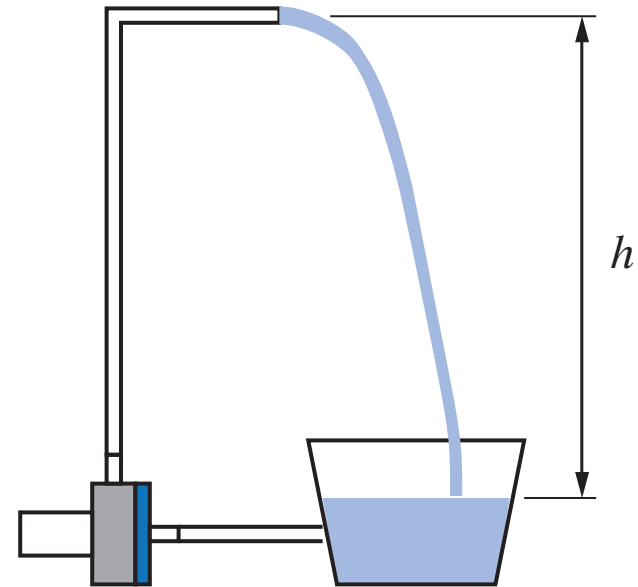

Pump Curve

Procedure

1. Measure Q with the outlet held at different h .
2. Plot $h = f(Q)$
3. Obtain a least squares curve fit to $h = f(Q)$.

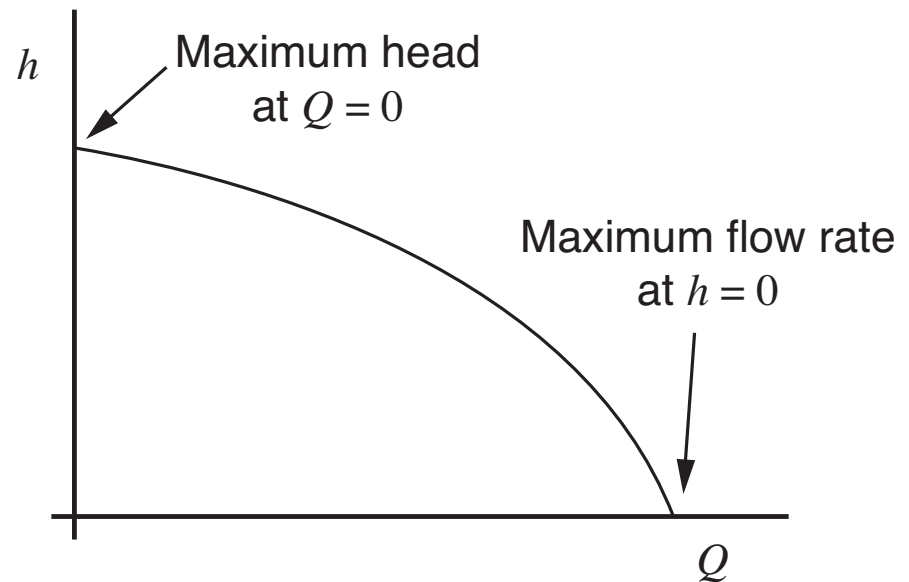

Pump Efficiency (1)

Each pump has an optimal operating point, i.e., an optimal (Q, h) that yields maximum efficiency. In most engineering applications, there are several pumps that can supply the desired flow rate at the necessary head. Given a choice of pumps that can meet the Q and h requirements, one should choose the pump that operates at the maximum efficiency.

What is efficiency?

$$\eta = \frac{\text{Output}}{\text{Input}}$$

The maximum efficiency point is between the maximum head condition ($Q = 0$) and the maximum flow condition ($h = 0$).

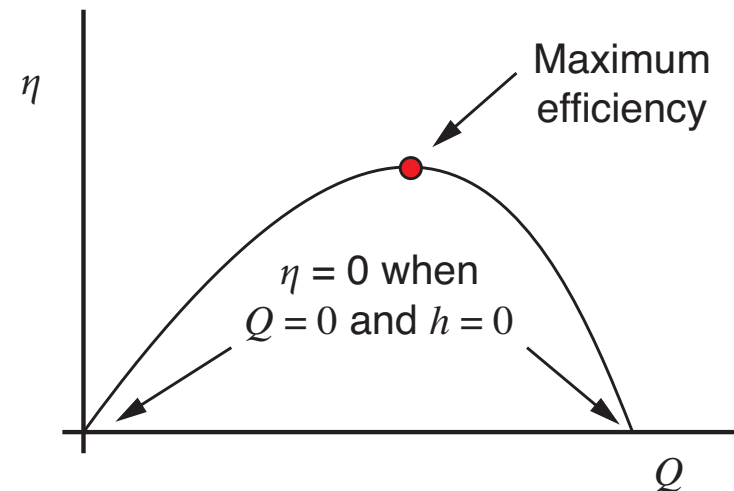

Pump Efficiency (2)

Efficiency

$$\eta = \frac{\text{Output}}{\text{Input}} = \frac{\text{Desired outcome}}{\text{Cost of obtaining the outcome}}$$

Each device has a conventional definition of *Output* and *Input*

For a pump:

Output = is the power delivered to the fluid

Input = is the power consumed by the motor

The units of *Output* and *Input* must be the same because efficiency is *dimensionless*.

Output and *Input* could be defined in terms of energy instead of power as long as the units are consistent. Recall that power is the rate of energy transfer, i.e., energy transfer per unit time.

NOTE: Your computed efficiency will be meaningless if your units are inconsistent.

Pump Efficiency (3)

Output is rate at which usable energy is transferred to the fluid

$$\begin{aligned}\text{Output} &= \text{Rate at which fluid is elevated} + \text{flow of kinetic energy in output stream} \\ &= \dot{m}gh + \frac{1}{2}\dot{m}v^2\end{aligned}$$

where

$$\begin{aligned}\dot{m} &= \text{mass flow rate (kg/s)} \\ g &= \text{acceleration of gravity (m/s}^2\text{)} \\ h &= \text{pump head (m)} \\ v &= \text{velocity of the water leaving the tube (m/s)}\end{aligned}$$

NOTE: Your computed efficiency will be meaningless if your units are inconsistent.

Pump Efficiency (4)

Input is the electrical power supplied by the motor

$$\text{Input} = VI$$

where

$$\begin{aligned} V &= \text{voltage supplied to the motor (V)} \\ I &= \text{current supplied to the motor (A)} \end{aligned}$$

Therefore

$$\eta = \frac{\dot{m}gh + \frac{1}{2}\dot{m}v^2}{VI}$$

NOTE: Your computed efficiency will be meaningless if your units are inconsistent.

Measuring Pump Power

The voltage across the pump motor is measured with a voltmeter in parallel with the power leads.

The current through the pump motor is measured with an ammeter in series with the positive lead to the pump.

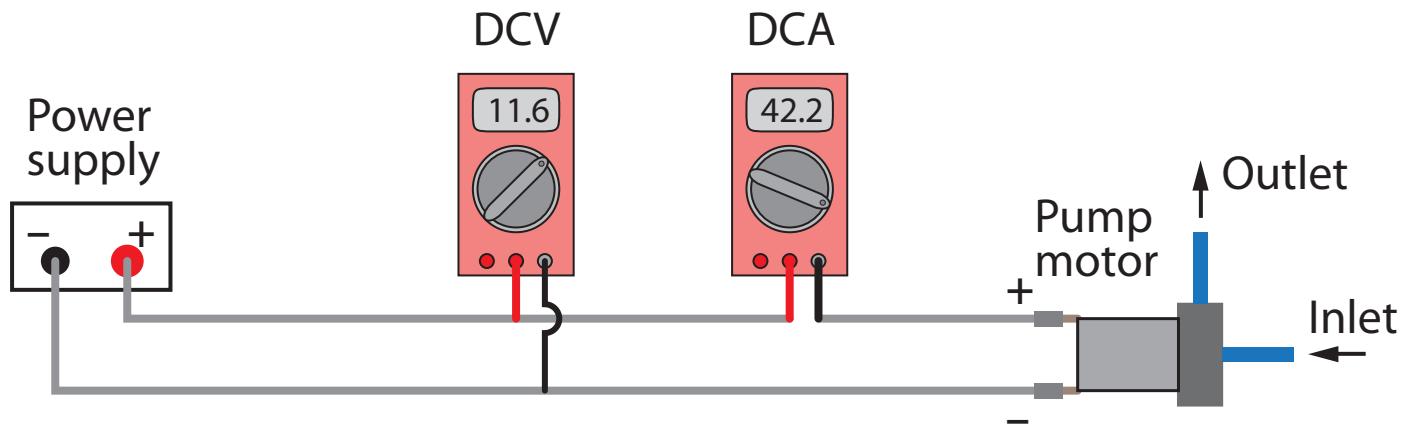

Pump Performance Testing

Measure				
h	Δm	Δt	V	I

Compute			
\dot{m}	Q	v	η

Definitions:

h = pump head = distance the water stream is elevated

Δm = mass accumulated in time Δt

Δt = time allowed for mass accumulation

V = voltage applied to pump motor

I = current drawn by pump motor

\dot{m} = mass flow rate

W = volumetric flow rate

v = fluid velocity in the tubing

η = pump efficiency

